

dCS Rossini Upsampling Network DAC

User Manual
Software Release 2.1x
February 2023

This product incorporates the following *dCS* proprietary technology:

Ring DAC™

Part No: DCS451659 V04

© **Data Conversion Systems Ltd. 2015 - 2023**

dCS Expanse is a registered trademark of Data Conversion Systems Ltd.

All rights reserved. No part of this publication may be reproduced, stored in or introduced into a retrieval system, or transmitted in any form, or by any means (electronic, mechanical, photocopying, recording or otherwise) without the prior written permission of *dCS*¹. Any person who does any unauthorised act in relation to this publication may be liable to criminal prosecution and civil claims for damages.

Information contained in this manual is subject to change without notice, and whilst it is checked for accuracy, no liabilities can be accepted for errors.

This manual is also for *dCS* Rossini Upsampling Network DAC APEX

¹ *dCS* is Data Conversion Systems Ltd. Company registered in England No. 2072115.

Contents

Using the <i>dCS</i> Rossini DAC for the first time.....	5
What's in the box?	5
<i>dCS</i> Mosaic	5
Positioning the unit	6
Important Safety Instructions	6
Condensation	6
Safety Notice	7
Made for iPhone® and iPad®	8
Step-by-Step Guide	9
Preliminaries	9
STEP 1 – Connecting the analogue outputs	10
Using a preamplifier	10
Using a power amplifier directly	10
Using the Balanced Outputs	10
STEP 2 – <i>dCS</i> Mosaic Network Connection	11
Basic set-up	11
Playing music with AirPlay	12
Using the Rossini DAC with Spotify Connect	12
Using the Rossini DAC with Tidal, Qobuz, Deezer and Internet Radio	12
Using the Rossini DAC with Roon	12
Playing MQA files	13
STEP 3 – Using the DAC's PCM Inputs	14
Connecting to a Dual AES Source	14
Connecting to a Single AES or SPDIF source	15
STEP 4 – Using the USB1 interface with a computer	16
Compatibility	16
Setting the USB Audio Class	16
Loading the Windows driver for USB Class 2	16
Basic setup with a PC	17
A word about Music Playing Software	17
Selecting the Rossini DAC as your Audio Output device	18
STEP 5 – Using the USB2 input	19
STEP 6 – Clocking	20
Using the Rossini Clock	20
Using the Rossini DAC in Master Mode with a Transport	21
Further suggestions	23
Renaming the digital inputs	23
Renaming your Rossini	24
Power Link	24
Front Panel.....	25
Display – <i>dCS</i> Mosaic	25
Display – DAC Mode	26
Remote Control Receiver	26
Control Modes	27
Power Button	27
Menu Button	27
Filter Button	27
Input button	28
Mute Button	28
Rotary Control	28
Rear Panel.....	29
Analogue Outputs	29
AES Digital Inputs	29
SPDIF Digital Inputs	29
USB Interfaces	30
Word Clock Inputs and Output	30
Network Interface	31
IR Remote Receiver	31
RS232 interface	31
Mains inlet	31
Label	31

The Menu	32
Using the Menu	33
INFORMATION Menu	34
Unit Status	34
Version	34
Contact	34
Update	34
AUDIO SETTINGS Menu	35
Phase	35
Filter	35
DSD Filter	35
Crossfeed (<i>dCS</i> Expanse)	36
Channel Swap	36
Balance	36
UNIT SETTINGS Menu	37
Sync Mode	37
Mapper	37
Output Level	38
Dual AES	38
USB Class	38
Buffer	39
Upsampling	39
RS232 Mode	39
CONFIGURATION Menu	40
Settings Lock	40
Save Configuration	40
Restore Configuration	40
Reset Input Names	40
Factory Reset	40
DISPLAY SETTINGS Menu	41
Brightness	41
Display On/Off	41
Logo On/Off	41
GENERATOR Menu	42
Channel Check	42
Phase Check	42
Burn In	42
Configuration with Mosaic Control	43
Specification	44
Maintenance and Support	46
Service and Maintenance	46
Replacing a Blown Mains Fuse	46
Cleaning the case	46
Limited Warranty	47
If you need more help	48
Software History	49
Software update	50
Index	51

USING THE *dCS* ROSSINI DAC FOR THE FIRST TIME

Congratulations on purchasing your *dCS* Rossini DAC.

Before using your unit, please read this section and the Step by Step Guide. This will enable you to set the unit up quickly and safely with your hi-fi system.

From time to time, *dCS* will release updated software that you can install yourself using the *dCS* **Mosaic Control**. Please check our website occasionally to see if new Rossini software is available, or consult your dealer.

What's in the box?

Check that the box contains the following items:

- *dCS* Rossini DAC
- Manual and Menu Guide
- *dCS* **Mosaic Control** Quick Reference Guide
- Power cable
- Ethernet cable
- USB cable type A-B
- 2 spare fuses

Notify your dealer as soon as possible if anything is missing or damaged. We suggest that you retain the original packaging for possible future use. If this is not possible, replacement packaging can be ordered from *dCS* or our distributors. Details can be found on our web site at www.dcsaudio.com.

The **Rossini DAC** is intended to be controlled by *dCS* **Mosaic Control** (see below) over an ethernet network.

A *dCS* Premium IR remote control is available as an optional extra.

dCS Mosaic

dCS **Mosaic** is a carefully assembled collection of hardware and software modules which provide easy and intuitive access to a vast catalogue of digital music. Whether it's high resolution files on a local server or an internet radio station broadcast from a distant land, *dCS* **Mosaic** ensures that the music you love is only a few convenient taps away. *dCS* **Mosaic** comprises of three parts.

dCS **Mosaic** is the name for the audio streaming and networked control functionality of *dCS* products.

dCS **Mosaic Control** is the name of the iOS and Android software application for music management and product control.

dCS **Mosaic Processor** is the physical hardware component and associated software that is installed in the *dCS* product to provide streaming functionality.

Please refer to the *dCS* **Mosaic Control** Quick Reference Guide for further information.

Positioning the unit

For best sound quality, the units in the Rossini range are designed to be mounted on separate shelves of a rack, although they may be stacked directly on top of each other if this is absolutely necessary. Place each unit on a firm, vibration free base, allowing convenient connection to the other parts of your system. To prevent overheating, we recommend that you leave some free space around the unit to allow for ventilation.



You can use the feet to level the unit. With all feet screwed fully home, the unit will sit level on a flat surface. If you need to do any levelling, you can unscrew any of the feet up to 3 complete turns, to give up to 3mm (1/8") of height adjustment.

Important Safety Instructions

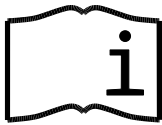

The following statements are required to comply with U.S. safety standard UL60065.

- Read these instructions.
- Keep these instructions.
- Heed all warnings.
- Follow all instructions.
- Do not use this apparatus near water.
- Clean only with dry cloth.
- Install in accordance with the manufacturer's instructions.
- Do not install near any heat sources such as radiators, heat registers, stoves, or other apparatus (including amplifiers) that produce heat.
- Do not defeat the safety purpose of the grounding-type plug. A grounding type plug has two blades and a third grounding prong. The third prong is provided for your safety. If the provided plug does not fit into your outlet, consult an electrician for replacement of the obsolete outlet.
- Protect the power cord from being walked on or pinched particularly at plugs, convenience receptacles, and the point where they exit from the apparatus.
- Only use attachments / accessories specified by the manufacturer.
- Unplug this apparatus during lightning storms or when unused for long periods of time.
- Refer all servicing to qualified service personnel. Servicing is required when the apparatus has been damaged in any way, such as power-supply cord or plug is damaged, liquid has been spilled or objects have fallen into the apparatus, the apparatus has been exposed to rain or moisture, does not operate normally, or has been dropped.

Condensation

If the DAC is cold and is moved into a warm room, condensation will form inside the unit. This interferes with normal operation. Remove the DAC from its packaging and let it stand for 1-2 hours, to allow it to reach room temperature and the condensation to evaporate.

Safety Notice



In the event of the unit developing a fault, please contact your dealer in the first instance.

If you decide to remove safety covers for any reason, disconnect the power cable first. Note that removing covers voids the warranty.

To maintain protection from electric shock, the unit **MUST** be connected to mains earth (ground) via the power cable. Also, unearthed systems do not give the best sonic performance.

Protect the product from dripping or splashing liquids. Liquid-filled objects such as vases must not be placed on the product.



This product is not suitable for operation at altitudes above 2000m.



This product is lead-free and complies with the RoHS directive.

Before connecting the power cable to the unit for the first time, please check that it has been set to the correct operating voltage for your mains supply. The unit's voltage setting is shown on the serial number label. If this does not match your local supply voltage, **DO NOT** attempt to use the unit. Contact your dealer to have the unit reset. Using the unit with the wrong mains setting for your local supply may result in serious damage to the unit and will invalidate the warranty. Do not attempt to reset the voltage yourself.

We do not recommend the use of mains regenerators. However, if you do wish to use a mains regenerator with variable voltage and frequency, we recommend that you set the voltage to match your local voltage and the frequency to either 50Hz or 60Hz **ONLY**.



Damage caused to your Rossini DAC by misuse of a mains regenerator or by a malfunctioning mains regenerator is not covered by the warranty.



Disposal at end-of-life - the symbol indicates that this product should not be treated as normal household waste. It should be recycled, so please take it to an approved collection facility.

Made for iPhone® and iPad®

The Rossini DAC is compatible with the iPhone and iPad models illustrated below.
Made for:



“Made for iPod” and “Made for iPhone” mean that an electronic accessory has been designed to connect specifically to iPod or iPhone respectively and has been certified by the developer to meet Apple performance standards. Apple is not responsible for the operation of this device or its compliance with safety and regulatory standards.

iPad®, iPhone, iPod and iPod touch® are trademarks of Apple Inc., registered in the U.S. and other countries.

Step-by-Step Guide

This section guides you through setting up the unit for basic operation.

Preliminaries

The Menu Guide sheet details the menu structure and describes the two most common set-ups.

For digital interfaces, use with cables designed for digital audio:

- for AES/EBU interfaces use 110Ω screened, twisted pair cables fitted with one male XLR connector and one female XLR connector.
- for Word Clock or SPDIF BNC interfaces, use 75Ω coax cables fitted with BNC plugs.



Word Clock interfaces require a simple DC-coupled connection. The interfaces may malfunction or not work at all if capacitor coupled cables or cables with built-in networks are used.

- for SPDIF RCA interfaces, use 75Ω coax cables fitted with RCA Phono plugs.
- for TOSLINK optical interfaces, use Toslink fibre-optic cables.
- for the Network interface, use an RJ45 Ethernet cable, such as that provided with the unit.
- for the USB1 interface, use a standard screened USB 2.0 cable fitted with one type 'A' connector and one type 'B' connector. The internal screen must be connected at both ends.

For analogue outputs, use with screened cables of the correct type:

- for balanced outputs, use screened, twisted pair cables fitted with one male XLR connector and one female XLR connector.
- for unbalanced outputs, use coax cables fitted with RCA Phono plugs.



Some “audiophile” cables have unusual grounding or screening arrangements, or do not have the correct characteristic impedance. If you have difficulty using such cables but the problems disappear when ordinary cables are substituted, please ask the cable manufacturer or your dealer for support.

Connect the power cable supplied to the power inlet on the DAC's rear panel, plug the other end into a convenient power outlet.



Please do not use an excessively heavy or inflexible power cable as this may damage the power inlet connector.



The cables supplied with the unit are “commercial grade”, because most owners will have their own “audiophile grade” cables or will prefer to make their own cable choices.

Set the rocker switch near the mains inlet to the **I** position, press the **Power** button.

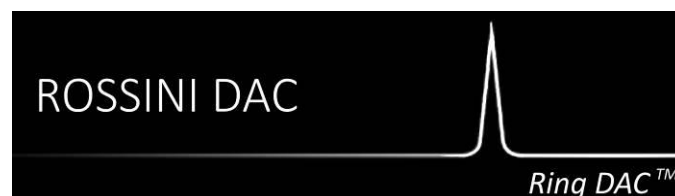

Wait about 10 seconds while the DAC configures itself. If the unit is likely to be set in an unfamiliar state, you can run the **Factory Reset** routine by pressing the buttons in this sequence: **Menu**, **▶**, **▶**, **▶**, **Menu**, **◀**, **◀**, **Menu**. Wait a few seconds while the unit resets itself.

STEP 1 – Connecting the analogue outputs

Choose one of the following two sections:

Using a preamplifier

- Set the preamplifier volume control to a low level.
- Connect either the balanced (XLR connectors) or unbalanced (RCA phono connectors) outputs on the DAC's rear panel to matching line level inputs on your preamplifier (probably labelled CD or AUX).
- Turn the DAC's rotary control clockwise to set the **Volume** to maximum (-0.0dB on the display).
- Slowly increase the preamplifier volume until the music is at the right level.
- If the preamplifier volume setting for a comfortable listening level is too high or too low, you may need to change the **Output Level** setting.
- Press the buttons in this sequence: **Menu**, **▶**, **▶**, **Menu**, **▶**, **Menu**.



Setting the **Output Level** to **6V** can cause some preamplifiers to distort. For this reason, we recommend the **2V** setting if a preamplifier is used.

Using a power amplifier directly

- Set the DAC's **Volume** to around -40.0dB as shown on the display.
- Connect either the balanced (XLR connectors) or unbalanced (RCA phono connectors) outputs on the DAC's rear panel to matching inputs on your power amplifier. Switch on the power amplifier.
- Turn the DAC's rotary control slowly clockwise until the music is at the right level.
- If the **Volume** setting for a comfortable listening level is higher than **-10.0** or lower than **-30.0**, try changing the **Output Level** setting.
- Press the buttons in this sequence: **Menu**, **▶**, **▶**, **Menu**, **▶**, **Menu**.

Using the Balanced Outputs



The most common fault reported when using our balanced outputs is hiss, unstable levels and a thin sound on both channels. This is caused by connecting the DAC's balanced output stage to an unbalanced input on an XLR connector with pin 3 left unconnected. This does not work correctly with a balanced and floating output stage – you must connect pin 3 to pin 1 (ground) to complete the signal path.

Another possible cause of this fault (probably on one channel only) is a broken cable.

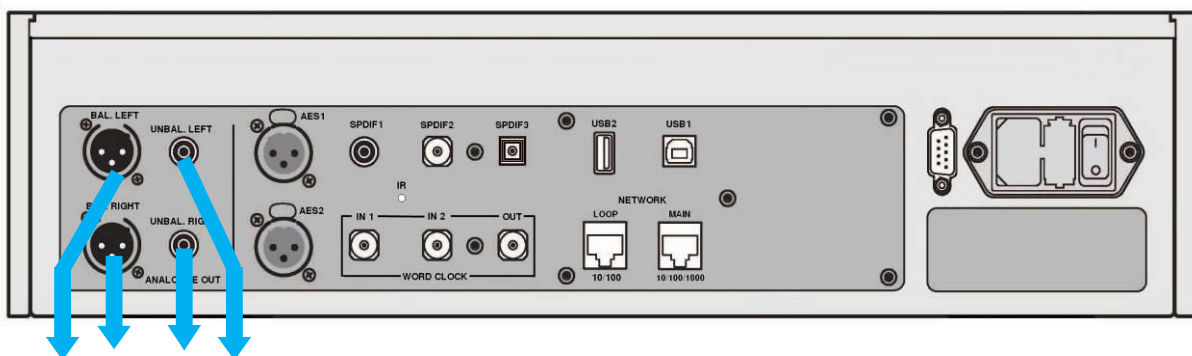

Balanced or unbalanced
Analogue outputs to
pre- or power amplifier

Figure 1 – Basic setup for the Rossini DAC



The Rossini DAC has independent balanced and unbalanced output stages, you can connect them to different amplifiers if you wish.

STEP 2 – dCS Mosaic Network Connection

The network audio functions of your *dCS* product utilize the *dCS Mosaic* Platform for access to local streaming sources (such as a music server on your network, Roon, or AirPlay) as well as internet services (such as Deezer, Qobuz, TIDAL, and Spotify). The **Rossini DAC** makes use of some UPnP components in order to stream music files from a network server.

Enabling network streaming of audio using a **Rossini DAC** relies on the presence of standard network infrastructure in your system. A description of the network will not be discussed in this manual but at a minimum the following components are required for system setup: Router, Computer, **Rossini DAC**, UPnP server (typically running on a NAS device), Wireless access point (WAP), and *dCS Mosaic Control* running on a compatible phone or tablet.

Please note that *dCS* only supports the use of wired Ethernet for the connections between the **Rossini DAC**, the internet router, and the UPnP server.

dCS uses MinimServer (<https://www.minimserver.com>) as our internal engineering reference UPnP server and that is the only UPnP server software for which we offer comprehensive support. There are a wide variety of UPnP server software packages on the market and most of them are confirmed to function correctly with *dCS Mosaic Control*, but we have only fully tested *dCS Mosaic Control* with MinimServer.

For assistance with configuring your network for *dCS Mosaic Control* please contact your dealer as they have significant experience in this area and will be able to assist you directly.

Basic set-up

- Connect the system as shown below.



Figure 2 – Using a Rossini DAC with a NAS

- Download *dCS Mosaic Control* from the app store that is appropriate for your device (e.g. the App Store for iOS devices or Google Play for Android).
- Connect the DAC's **Network** interface to the Ethernet network.
- Connect the control device (e.g. phone or tablet) to the network.
- Launch *dCS Mosaic Control* to locate and control your **Rossini DAC**. (Please see the online Mosaic User Guide for full details: <https://dcs.community/mosaic-user-guide>)

Playing music with AirPlay

When the DAC is connected to a network, music can be streamed from an Apple device via AirPlay to the DAC. When AirPlay is active, the DAC's Network input is automatically selected.



The lower Output Level settings are intended to prevent accidents when driving the amplifiers directly and AirPlay is in use, as the volume set by the sending device can be very high.

Using the Rossini DAC with Spotify Connect



Spotify lets you listen to millions of songs – the artists you love, the latest hits and discoveries just for you.

If you are a Spotify user, you can control the DAC using your Spotify App.

1. Connect the DAC to the same Wi-Fi network as your phone, tablet or PC running the Spotify app.
2. Open the Spotify app and play any song.
3. Tap the song image at the bottom of the screen.
4. Tap the Connect icon. 
5. Pick the Rossini DAC from the list.

For further information on how to set up and use Spotify Connect, please visit www.spotify.com/connect

Licenses

The Spotify Software is subject to third-party licenses found here: www.spotify.com/connect/third-party-licenses.

Using the Rossini DAC with Tidal, Qobuz, Deezer and Internet Radio

dCS Mosaic Control should be used to play music from online streaming services such as Tidal, Qobuz, Deezer, Internet Radio etc. Please see **dCS Mosaic Control** Quick Reference Guide and the **dCS Mosaic** user guide (<https://dcs.community/mosaic-user-guide>) for further information.

Using the Rossini DAC with Roon



The Rossini DAC is Roon Ready. If you have a Roon account, you need to install Roon server on your NAS drive or in a networked PC. You can then use Roon remote to control playback. Roon requires a fairly powerful processor, so please check the Roon website when choosing a NAS drive.

<https://roonlabs.com/>

Playing MQA files



MQA (Master Quality Authenticated) MQA is an award-winning British technology that delivers the sound of the original master recording. The master MQA file is fully authenticated and is small enough to stream or download.

Visit www.mqa.co.uk for more information.

The MQA logo is a trademark of MQA Limited and is used under licence.

Rossini DAC v1.1 onwards features a full MQA decoder.



MQA files streamed bit-perfect via the **Network** (for example from Tidal Masters) or **USB2** interfaces will be unfolded and rendered to the original sample rate. The standard **MQA** icon will appear on the display, together with the decoded sample rate.



This logo is displayed when an MQA studio file is being played.

MQA data that has been unfolded by another device to 24/88.2 or 24/96 and is presented bit-perfect to the **USB1**, **AES** or **SPDIF** interfaces will also be rendered to the original sample rate.

When performing MQA playback via the Network, the type of MQA stream is indicated in **dCS Mosaic Control**.



MQA decoding is not possible if the original MQA data has been changed.

In order for the MQA authentication process to work correctly the file's metadata tags need to include codes that the MQA decoder verifies. If you have edited the metadata of your MQA files, then the tags may have become corrupted. This is a very common problem as the tags and artwork provided with the files may not match a listener's preferred metadata tagging convention. This is also a common issue with files ripped from an MQA-encoded CD.

This problem is easily solved using the MQA Tag Renaming Application. When run against files that are exhibiting this issue this application will read the MQA markers in the bit stream and apply the appropriate metadata tags to the files. More information on the Tag Renaming application can be found here:

<https://www.mqa.co.uk/customer/tag435sdf43te>

STEP 3 – Using the DAC's PCM Inputs

The DAC has 5 standard PCM inputs, which may be used with a wide variety of sources.

Switch on the source equipment. If appropriate, load a disk / tape / file and set the machine in PLAY mode to ensure it is generating a digital audio data stream.

Choose one or both of the following two sections:

Connecting to a Dual AES Source

- Check that your source equipment is capable of Dual AES operation and is set up correctly. This will probably be a *dCS* SACD Transport, a *dCS* Upsampler or a sound server.

:A Press **Menu, ►, ►, ►, Menu, ►** to select the **Unit Settings > Dual AES** menu page and use the Menu button to ensure it is set to **Auto**.

- Connect the AES1 (or AES A) output on your source equipment to the **AES1** input on the DAC's rear panel and the AES2 (or AES B) output to the **AES2** input, using two XLR cables. Ensure the cables are not swapped.

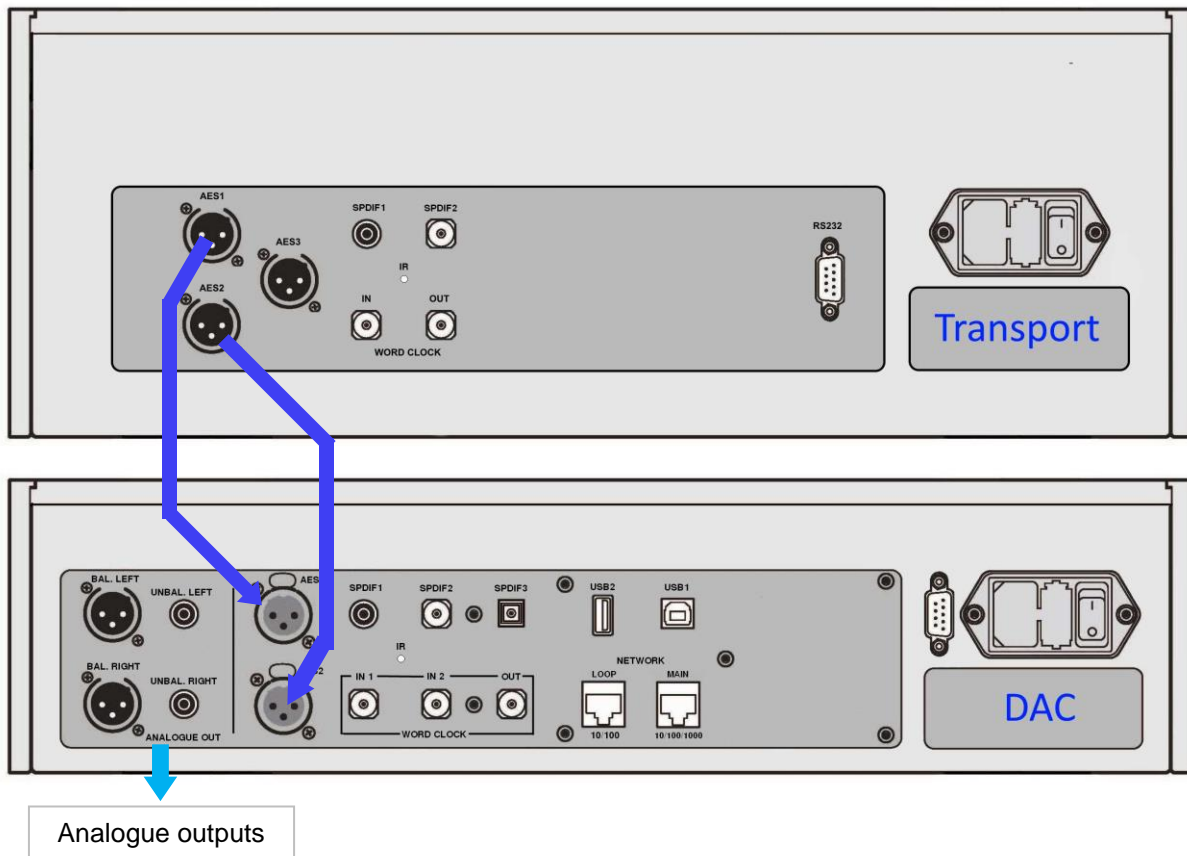

Figure 3 – Using the Rossini DAC with the Rossini CD/SACD Transport

- Use the **Input** button to select the **AES1** input.



If this icon is not displayed, open the Menu and select **Unit Settings > Sync Mode > Audio Sync**.

The DAC will lock to the source and automatically select **AES1+2**, displaying **24/352.8** for example, if the source is generating that format.

Connecting to a Single AES or SPDIF source

Most digital audio source equipment (such as CD transports, DVD players) is fitted with a single wire digital output, usually on an RCA phono connector. Satellite receivers often have a Toslink optical output.

- Connect your source equipment to the matching input on the DAC's rear panel using a suitable cable.
- Press the Input button repeatedly until your chosen input is displayed. This will be either **AES1**, **AES2**, **SPDIF1** (RCA), **SPDIF2** (BNC) or **TOS** (Toslink).



If this icon is not displayed, open the Menu and select **Unit Settings > Sync Mode > Audio Sync**.

The DAC will lock to the source, displaying **16/44.1** for example, if the source is a CD player.



If the inputs have been renamed, the standard names will not be displayed.



Why does the DAC display 0 bits? Is it faulty?

No, the DAC is working correctly. When the source equipment is connected but is not playing, there is no data – just digital silence. The DAC correctly reports zero active data bits until the source starts playing, then it detects the number of active bits and updates the display. 0 bits may be displayed briefly between tracks also.

STEP 4 – Using the USB1 interface with a computer

If you do not want to use a computer, you can miss out this step.

Compatibility

The **USB1** interface can be connected to Windows™ 10, Windows™ 8.1, Windows™ 7 (SP1), Mac™ OS X (10.5.4 or later) PCs or a sound server, running software to stream PCM data.

The interface should work with Linux Ubuntu servers and computers fitted with USB 2.0 interfaces that natively support USB Audio Class 1 or Class 2 operation, but this has not been extensively tested.

Setting the USB Audio Class

There are two USB Audio classes, one of which must be set during system set-up. The DAC is shipped set to USB Audio Class 2.

USB Audio Class 1: The interface operates without a special driver at up to 96kS/s.



To select Class 1, open the menu, navigate to the **Unit Settings > USB Class** menu page. The button sequence is: **Menu**, **▶**, **▶**, **Menu**, **▶**, **▶**, **▶** and then use the **Menu** button to select the **Class 1** icon.

USB Audio Class 2: The interface operates at up to 384kS/s (including DSD/64 over PCM).

For Mac OS X, version 10.6.3 or later is required.

Windows 10 Creator's Edition supports Class 2 operation.

For earlier versions of Windows, the *dCS* USB Class 2 Driver 2018 must be installed onto the computer before use (see below).



To select Class 2, open the menu, navigate to the **Unit Settings > USB Class** menu page. The button sequence is: **Menu**, **▶**, **▶**, **Menu**, **▶**, **▶**, **▶** and then use the **Menu** button to select the **Class 2** icon.



If an older version of the *dCS* USB Class 2 driver is installed on your Windows PC, please un-install it and install the current version.

Loading the Windows driver for USB Class 2

- If ASIO4ALL or any other ASIO driver (e.g. for a sound card) is loaded on your computer, please uninstall it - otherwise the *dCS* driver will not work correctly.
- Make sure the DAC is set to USB Class 2 - otherwise the driver installation will fail.
- Power up the DAC and the computer.
- Connect the DAC's **USB1** port to the computer's USB port.
- Go to <http://dcsaudio.com/products/rossini-DAC/>, click the **Support** link and download the *dCS* USB Audio Class 2 Driver 2018.
- Unzip the file to a temporary directory and run the file.
- Follow the on-screen prompts.
- Wait until installation is complete, then re-start the computer.



If you connect the DAC set for USB Audio Class 2 to a Windows computer without first loading the driver, the interface will not operate.

Basic setup with a PC

- Connect one of the computer's USB ports to the **USB1** port on the DAC's rear panel.
- To select the **USB1** port, either use the *dCS Mosaic Control* app to select the required input or press the front panel **Input** button repeatedly until **USB1** is displayed.



If this icon is not displayed, open the Menu and select **Unit Settings > Sync Mode > Master Mode**.

This is the DAC's default **Sync Mode** for the USB and Network interfaces. The DAC does not lock to the source clock, but uses the DAC's internal clock instead. A control signal is sent back to the source to control the delivery of data bursts from the computer. This arrangement avoids the use of the computer's inaccurate and jittery clock.

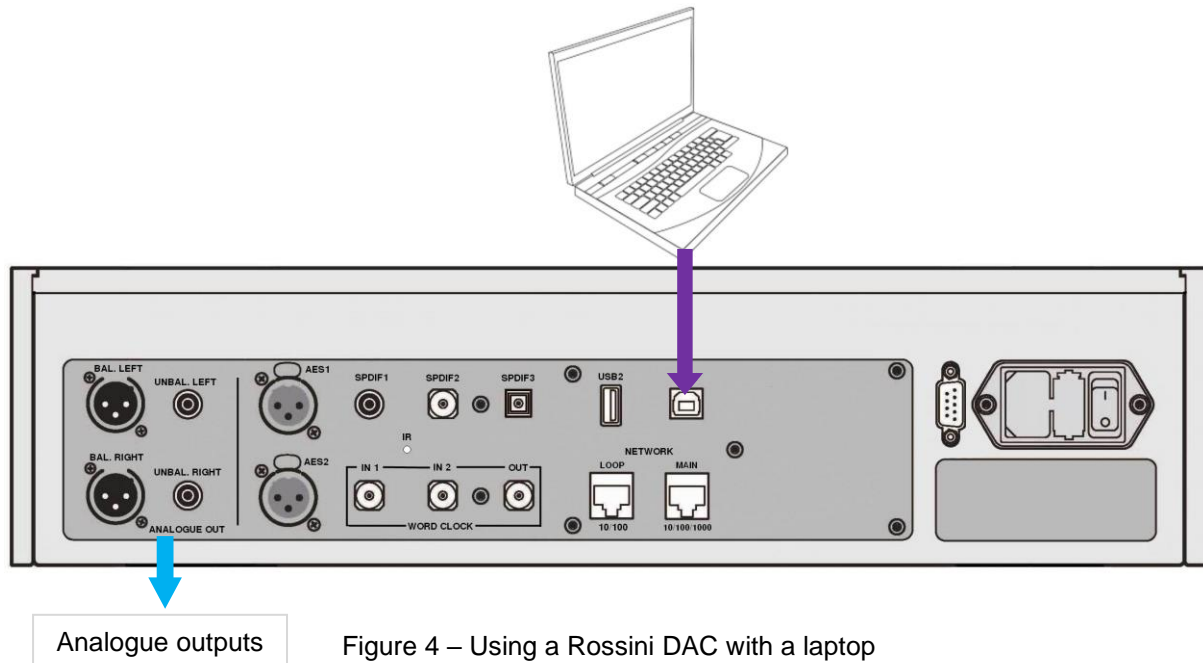

Analogue outputs

Figure 4 – Using a Rossini DAC with a laptop

A word about Music Playing Software

There are countless programs that can play music on Windows and Apple Mac PCs. Unfortunately, not all of them present the data completely unprocessed to the USB ports. For example, Windows Media Player re-samples all data to 24 bits at the original sample rate, while iTunes rate converts data as necessary to the output sample rate set in the OSX Audio MIDI Set-up panel.

With such a proliferation of playing software, and with updates being issued daily, it is impossible for *dCS* to be fully up-to-date with the behaviour and performance of all programs. If you have questions or problems, we would urge you to take them up with your software vendor. What we will say is that different programs operate very differently and it is well worth finding out exactly how your particular program processes the audio.

We suggest that you use a premium music streaming program, such as JRiver Media Center (Windows or Mac) or Audirvana (Mac), rather than relying on the software bundled with the operating system.

Selecting the Rossini DAC as your Audio Output device

Whichever program you are using to play your music, your computer may not automatically select the Rossini DAC as the preferred playback device. Once you have connected the DAC and switched it on, you can correct this as follows:

Mac OSX™ - Open **Finder**, click on the **Go** tab and select **Utilities** > **Audio MIDI Setup**. Select **dCS Rossini DAC USB ...** from the list on the left-hand side, right-click on it, and choose “**Use this device for sound output**” from the drop down list. Set the **Format** to **384000.0Hz** and **2ch-24bit Integer**. Close **Audio MIDI Setup**.

Windows 10™ / 8.1™ / Windows 7™ - Go to **Start** > **Control Panel** > **Sound**. In the **Playback** panel, right-click **dCS Rossini DAC Audio** and choose **Set as Default Communication Device**. Click the **Enhancements** tab and check **Disable all enhancements**. Select the **Advanced** tab, choose **24 bit, 384000 Hz (Studio Quality)** from the drop-down box. Check the 2 boxes under **Exclusive Mode**, click **OK** and **OK** again to close the **Sound** panel.

Open your streaming program, select the **Rossini DAC** in the **Options** or **Preferences** panel and play some music.



If the **USB1** input stops responding and cannot be found by the PC, it may be that the USB firmware has been corrupted. This can happen if the USB connection is not secure while playing a track. Disconnect the USB cable, change the **Unit Settings > USB Class** setting, then change it back and re-connect the USB cable. This will usually solve the problem.

STEP 5 – Using the USB2 input

You can play compatible music files that are stored on a flash drive, formatted as FAT16, FAT32 or un-encrypted NTFS. Drives in other formats are not compatible.

- Connect the drive to the **USB2** port and select the **USB2** input.
- Hold down the **Menu** button for 2 seconds to open the browser. **Please Wait** may be displayed for a few seconds, depending on the capacity of the drive, then the name of the drive. Press the **Menu** button.
- The files and folders in the root directory will be listed on the display. Use the **▶** and **◀** buttons to move the blue highlight. (The blue highlight is a cursor, it does not move when the next track starts playing.)

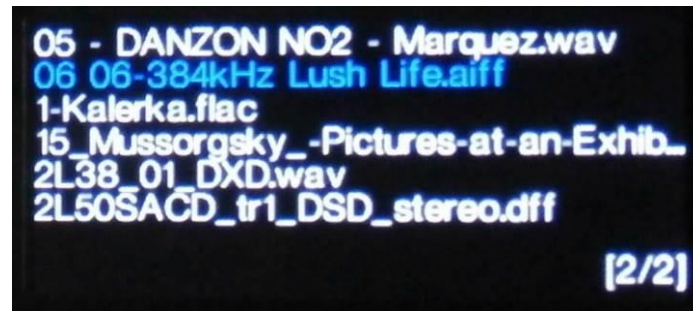

- Press the **Menu** button to either start playing a file or to move into a sub-directory.
- If you need to navigate back up the directory structure, press the **Mute** button.
- Press the **Power** button briefly to close the browser.

The operation of the front panel controls returns to normal. The name of the track, the play icon and the track elapsed time will be displayed.

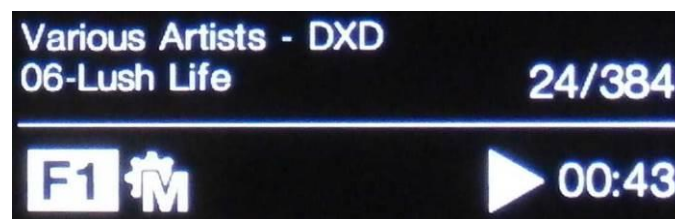

The DAC will play all the files in that directory in the sequence they appear on the flash drive and then stop.

- Use the remote control's **Previous Track**, **Next Track**, **Play/Pause** and **Stop/Eject** buttons to control playback.
- To select a different directory or re-start playback, open the browser again.



Do not try to play non-audio files, as this can cause the interface to malfunction. If you do this by accident, re-boot the DAC.



You can use the **USB2** interface with a low-power USB HDD if you wish, provided it is in a compatible format. We have used drives with capacities up to 1TB successfully, although the read time can be quite long. For larger capacities, please use a NAS drive connected via a network instead.

STEP 6 – Clocking

So far, the system has been set up to lock to the clock generated by the source, or in Master Mode for asynchronous Network and USB interfaces. This is the simplest arrangement, but it does not give the very best sonic performance due to clock jitter.

Using the Rossini Clock

The performance can be improved further by adding a Rossini Master Clock to the system.

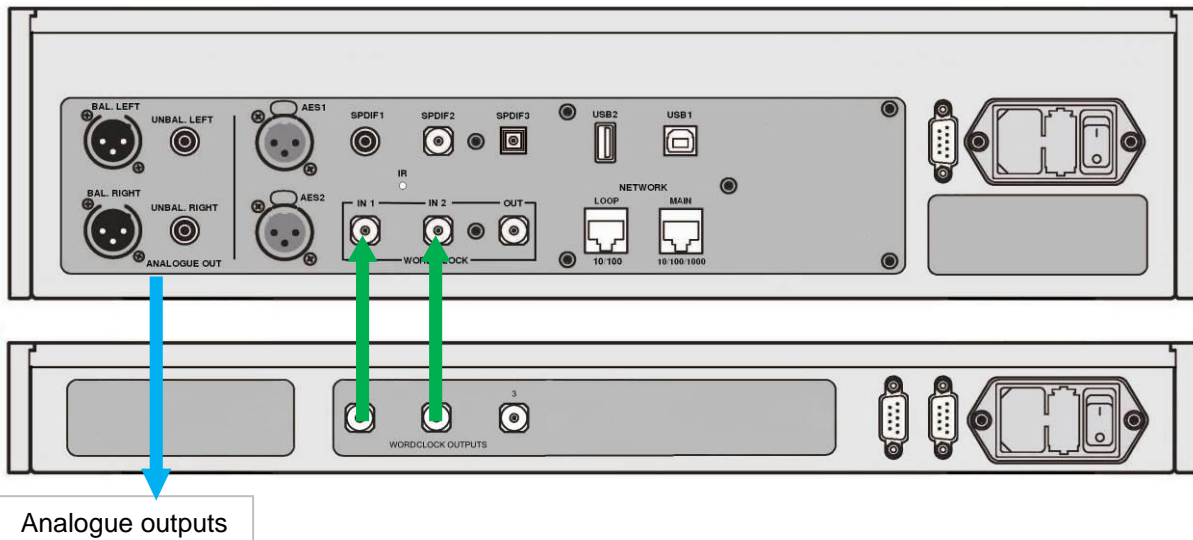

Analogue outputs

Figure 5 – Using the Rossini DAC and Clock together

- Use the DAC's **Input** button to select the input you want to lock to the Clock – this can be the Network, USB1 or USB2 input only.
- Power up the Rossini Clock.
- Connect the Clock's **Word Clock Output 1** to the DAC's **Word Clock Input 1** and the Clock's **Word Clock Output 2** to the DAC's **Word Clock Input 2**.



Set the DAC's **Unit Settings > Sync Mode** menu page to **Word Clock 1-2 Auto** and allow the system to re-lock. The "W1" or "W2" icon will be displayed.

- Play some music.

The Rossini Clock provides the DAC with 44.1kHz and 48kHz word clock simultaneously, ensuring it can stay locked to any valid sample rate.

- If you want to lock sources connected to the AES or SPDIF inputs to word clock, we suggest that you consider using the Vivaldi Master Clock to synchronise the system. It has many more outputs than the Rossini Clock.



Please note if you lock one of the DAC's AES or SPDIF inputs to a Master Clock, the source equipment (e.g. a CD player) **MUST** be locked to the same Master Clock, otherwise you will experience periodic clicks, dropouts, noises or distortion on the output. For more information, please see the manual for the Vivaldi Master Clock.

Using the Rossini DAC in Master Mode with a Transport

If your source equipment has a word clock input, you can reduce jitter by using the DAC in Master Mode and slaving the source to it.

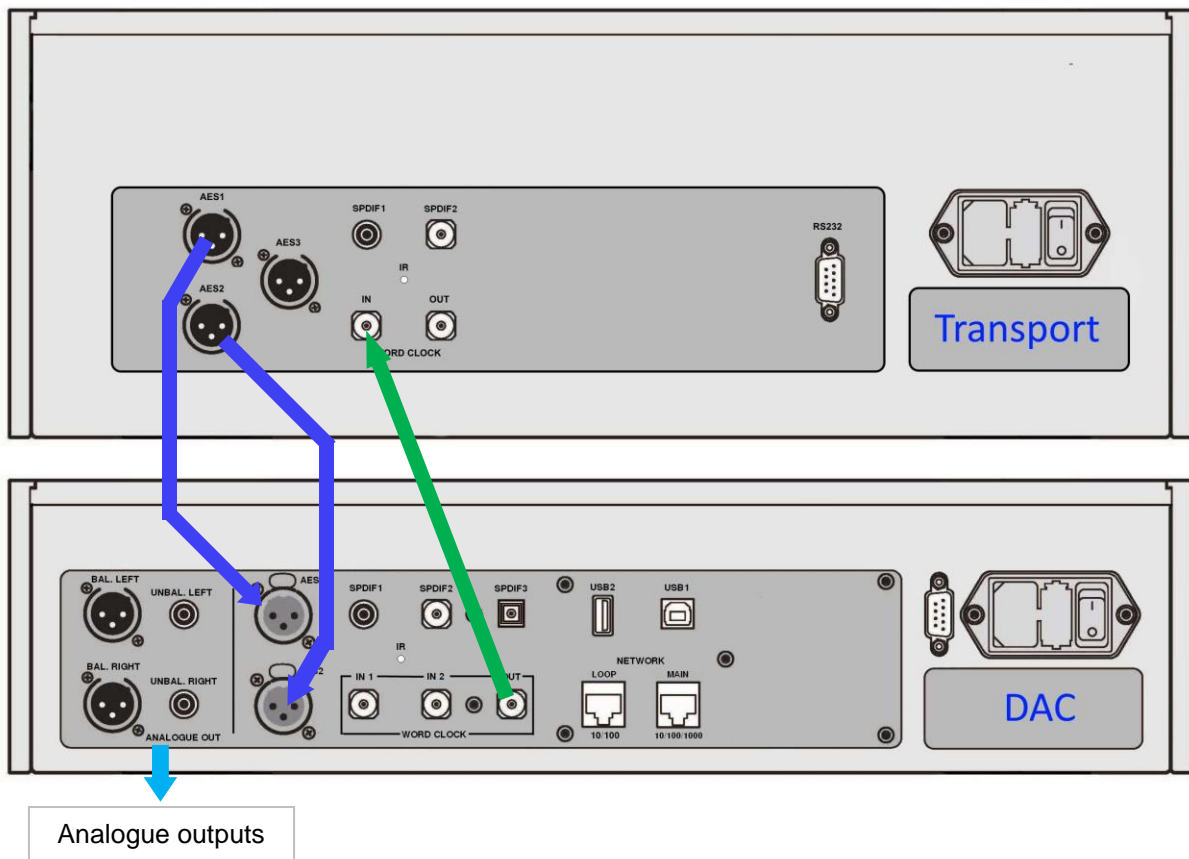

Figure 6 – Using the Rossini DAC in Master Mode with a Rossini Transport

- Connect the system as shown above.
- Use the DAC's **Input** button to select the input you want to use (**AES1+2** in the example).



Set the DAC's **Unit Settings > Sync Mode** menu page to **Master** mode.



The Rossini Transport will lock to the DAC's 44.1kHz word clock and display this icon.

- If you want to listen to CD playback in native 16/44.1 format, connect one of the Transport's SPDIF outputs to the DAC's matching input. Select that input and set it to Master Mode also.

Using the Rossini DAC and Clock with a Transport

The Rossini Clock has a third output (normally fixed at 44.1kHz), which may be used to clock another source, such as an SACD Transport.

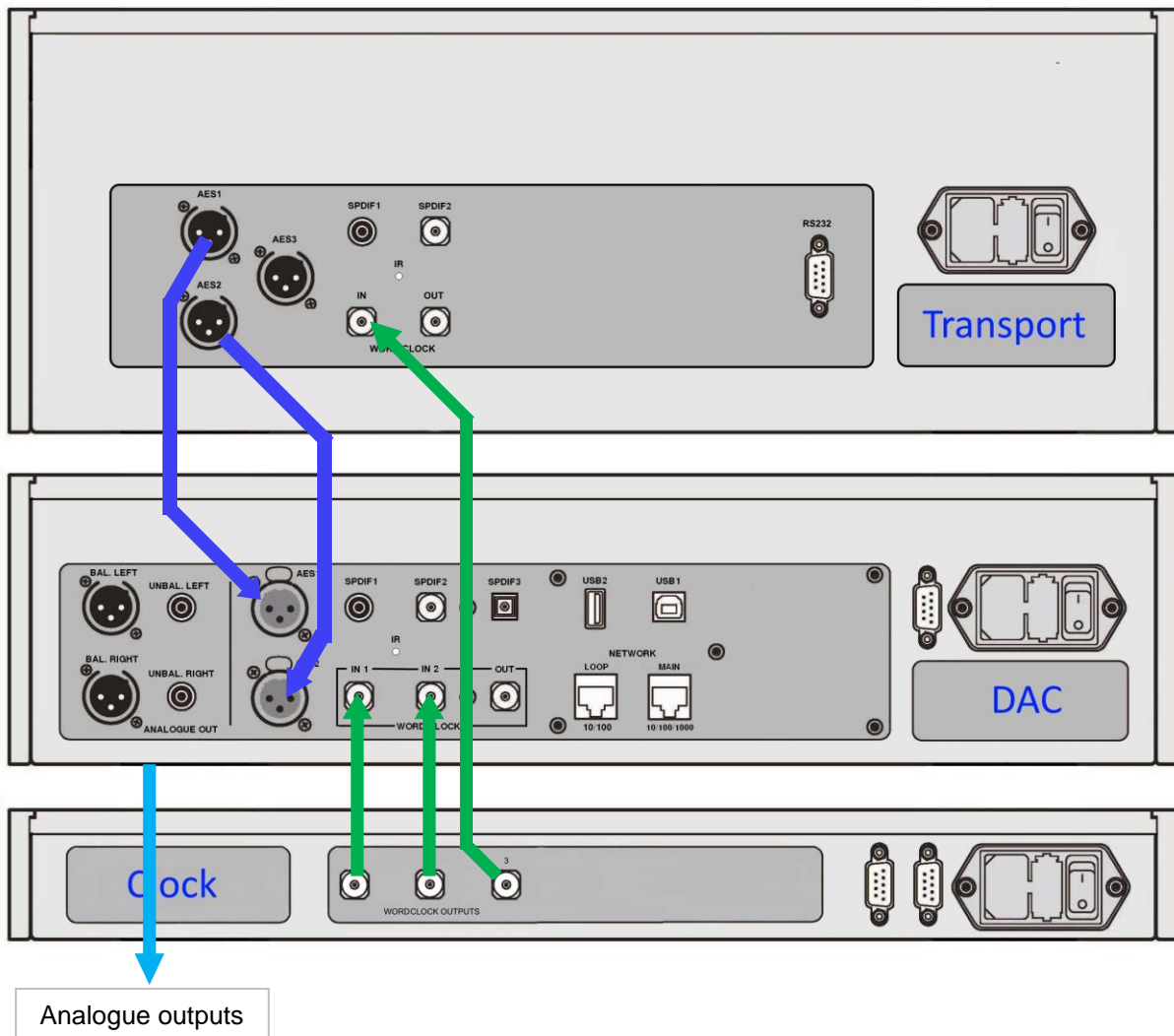

Figure 7 – Using the Rossini DAC, Clock and Transport together

- Connect the system as shown above.
- Use the DAC's **Input** button to select the input you want to use (**AES1+2** in the example).



Set the DAC's **Unit Settings > Sync Mode** menu page to **Word Clock 1-2 Auto** mode.



The Rossini Transport will lock to the word clock and display this icon.

- If you want to listen to CD playback in native 16/44.1 format, connect one of the Transport's SPDIF outputs to the DAC's matching input. Select that input and set it to **Word Clock 1-2 Auto** mode also.

Now, sit back and enjoy the music.

When you have finished listening, you can either keep the DAC warm by setting it to Sleep mode (press the **Power** button briefly) or switch off (hold down the **Power** button until **SWITCHING OFF** is displayed, then release).

Further suggestions

- If you wish, you can set the DAC to insert a DSD upsampling stage at the end of the PCM oversampling sequence by setting the [Unit Settings > Upsampling](#) menu page to **DSD** or **DSDx2** (see page 39). This feature is active when the DAC receives PCM data only.
- The **Mapper** feature changes the way data is presented to the Ring DAC™. Try the 3 options and decide which you prefer. Note that your choice may depend on your choice of music.
- If you are using a Rossini Master Clock, try turning the Dither feature on. Please refer to the Clock manual for more information.

Renaming the digital inputs

The DAC's inputs can be renamed to suit your particular system using a computer running a terminal emulator program. The procedure using a Windows PC with TeraTerm is described here, but other programs such as PuTTY or ZTerm can be used. If you have difficulty with this, please ask your Dealer for help.

- Power up the DAC and a Windows PC.
- If necessary, download Tera Term from <http://en.sourceforge.jp/projects/ttssh2/releases/> and install it on your PC. (If the link is broken, please search for the latest version of Tera Term online.)



Set the DAC's [Unit Settings > RS232](#) menu page to the **Text** option.

- Use a USB-to-RS232 adapter cable to connect the DAC's **Test** port to one of the PC's USB ports.
- Run ttermpro.exe.
- Click the **Serial** button – Tera Term will automatically select the port connected to the DAC. Click **OK**.
- Click **Setup > Serial Port**, set the **Baud rate** to **115200** and click **OK**.

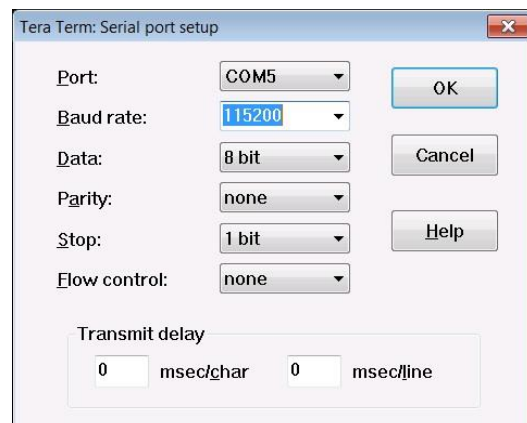

- In the terminal window, type the command: **NAME n = newname** where:
 - **n** is the number corresponding to the standard input name in the list below,

AES1	0	AES2	1	AES1+2	2	SPDIF1	3
SPDIF2	4	TOS	5	Network	6	USB1	7

- **newname** is the personalised name you want to use for that input, such as CD-SACD, TV or COMPUTER. It can be up to 8 characters long, consisting of:

capital letters A-Z, numbers 0-9 or + - / = . : ? ! @ &

- Press **Enter**.

For example:

- to rename the **AES1+2** input to SACD, type: **NAME 2 = SACD** and press enter.
- to rename the **TOS** input to TV, type: **NAME 5 = TV** and press enter.



Later on, if you want to revert to the standard input names (**AES1**, **SPDIF1**, etc.), select the [Configuration > Reset Input Names](#) menu page.

Your customised input names will be permanently deleted.

Renaming your Rossini

To identify more than one Rossini unit on the same network, you can change the network name of each Rossini Player or DAC as follows.

- Connect a PC, tablet or phone and the Rossini to the same network.
- Press the Rossini's **Menu** button 3 times, note the IP address of the unit, press the **Power** button briefly to close the menu page.

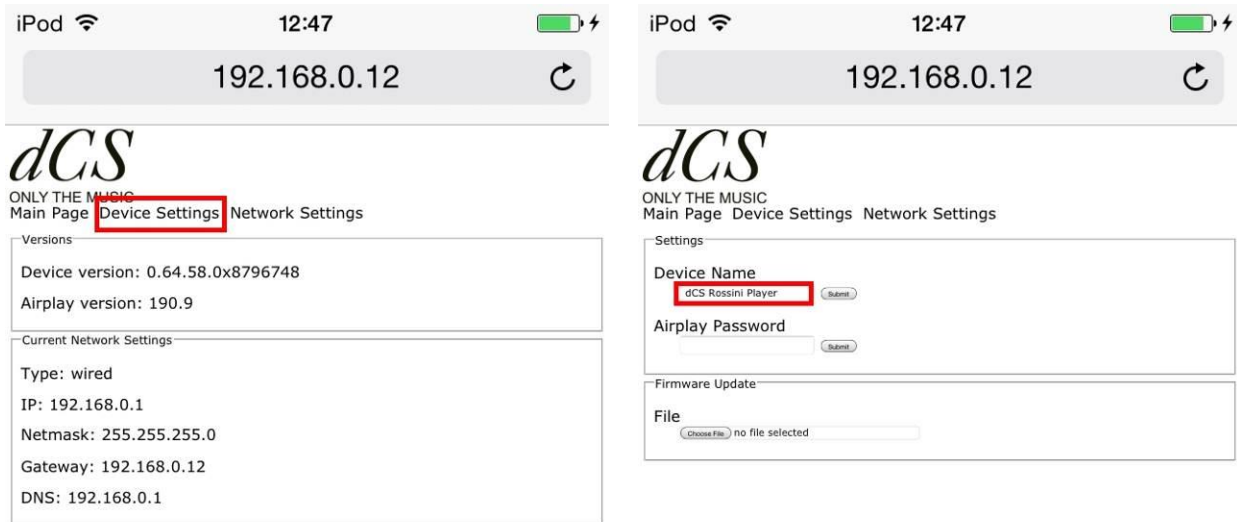

- Open a web browser and go to the Rossini's IP address.
- Click or tap **Device Settings**.
- Click or tap the box under **Device Name**, enter the new name and click or tap **Submit**.

This feature will be available from the Rossini app soon.

Power Link

Connecting the DAC's RS232 port to the Rossini Clock's RS232 Loop port allows both units to be set to sleep / wake / off by pressing the DAC's Power button, or by one remote control command.

A screened cable fitted with two 9-way female D-type connectors wired pin-to-pin is required.

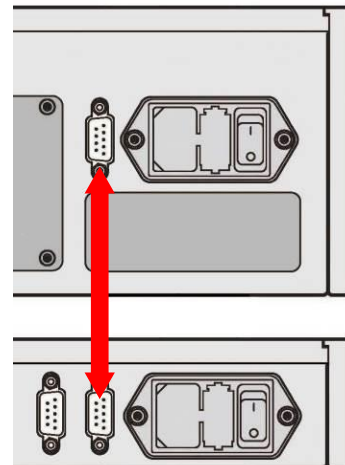

The Power Link feature will only work if both units are set to the same RS232 mode (Text or Binary).

From completely off (not Sleep), if you switch the Clock on first, the units will be automatically set to the same mode.

FRONT PANEL

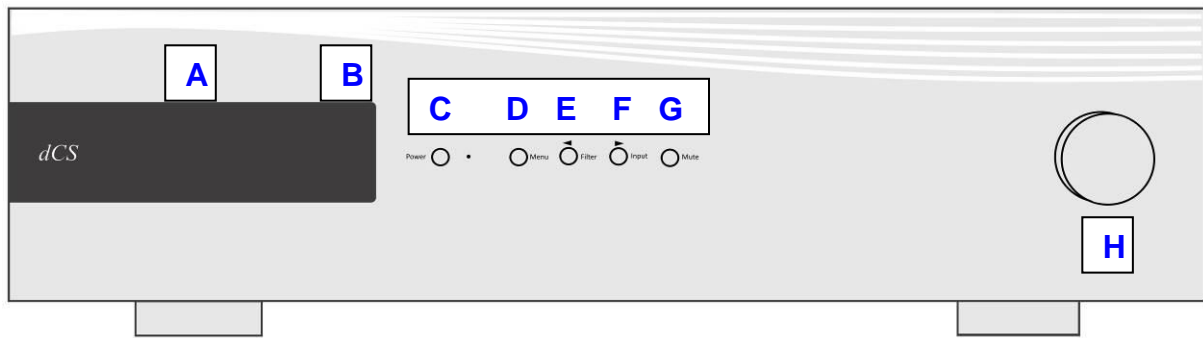

Figure 8 – Front panel

Display – dCS Mosaic









While streaming music from the Network or a USB flash drive, the display (A) is split into 4 areas:



Area 1: The Artist, Album name & Track name or File name (this depends on the file type and the metadata).

Area 2: The data rate - word length and sample rate for PCM, DSD or DSDx2.

Area 3: The status icons are displayed here.

	Filter setting when receiving PCM data.		Filter setting when receiving DSD data.
	The sync source (see Sync Mode on page 37)		Settings Lock is on
	Phase is inverted.		Channels are swapped.
	Decoding MQA format data.		Decoding MQA Studio format data.
	The display is turned off.		

Area 4: The Play or Pause icon and the track elapsed time.

When the volume is changed, the volume setting is displayed in large text for a few seconds.

Display – DAC Mode

With one of the digital inputs selected or if the Network input is selected but is not active, the display is again split into 4 areas:



Area 1: The selected input.

Area 2: The data rate - word length and sample rate for PCM or DSD or DSDx2.

Area 3: The status icons are displayed here, these are the same as for the Network input except for:



Wrong clock detected

Area 4: The Volume control taper and the current Volume setting in numbers.

Details of the menu displays are shown in the Menu section on page [32](#).



All LCD displays suffer from staining if they are left for long periods displaying the same image. To avoid unnecessary display wear, we recommend switching off or setting the unit to Sleep mode at the end of the listening session.

Remote Control Receiver

If you are using an IR remote control, aim the handset towards the receiver (B) for best sensitivity.

Control Modes

The functions of the front panel controls depend on the current operating mode of the DAC, as shown in the table below.

MODE	Power	Menu	Filter	Input	Mute
DAC / Network					
Menu	Close	Select	◀ Menu	Menu ▶	---
USB2 Browser	Close	Select	Cursor ▲	Cursor ▼	Folder ▲

Power Button

To switch on, ensure the rear panel power switch is set to **I** and press the **Power** button (C) on the front panel once. Note that the unit cannot be turned on from the remote control.

To set the unit to sleep mode, press the **Power** button once. The main display will turn off, the LED over the button will illuminate and the mechanism will stop, but the unit will remain close to running temperature. Press again to return to normal operation.

To switch off, hold down the **Power** button for about 5 seconds until **SWITCHING OFF** appears on the display, then release it.

Pressing the **Power** button briefly will close the menu or the browser.

Menu Button

Press the **Menu** button (D) to open the menu, select menu pages and change settings. See the Menu section on page [32](#) for information on using the menu features.

With a USB flash drive fitted to the **USB2** port, hold the **Menu** button down for 2 seconds to open the file browser and select folders or tracks.

Filter Button

When receiving PCM data, the Filter button (E) selects a different anti-image filter. See page [35](#) for more details.

When the menu or browser is open, the **Filter** button changes to the ◀ button, used to page backwards through the menu or up the track list.

Input button

Press the **Input** button (F) repeatedly to cycle through the available digital inputs.



Inputs which are not connected to an active source do not appear in the list and so cannot be selected.

The source sample rate is automatically detected. The full sequence is:

..., **NETWORK, AES1, AES2, AES1+2, SPDIF1 (RCA), SPDIF2 (BNC), TOS (Toslink), USB1, ...**



AES1+2 is not available if the **Unit Settings > Dual AES** menu page is set to **OFF**.

When the menu or browser is open, the **Input** button changes to the **▶** button, used to page forwards through the menu or down the track list..

It is also possible to select inputs directly from the **dCS Mosaic Control** application via

SETTINGS > AUDIO > Source

Mute Button

Use the **Mute** button (G) to mute and un-mute the analogue outputs. When the unit is muted, **MUTE** appears on the display.

When the browser is open, the **Mute** button navigates up to the previous directory (if one exists).

Rotary Control

The Rotary Control (H) usually controls the **Volume** setting. The **Volume** setting changes in 0.5dB steps between 0dB (full volume) and -50dB, in 1dB steps down to -80dB and then mutes below -80dB. When the volume is changed, the volume setting is displayed in large text for a few seconds.



When the **Balance** menu page is open or the remote **Balance** button has been pressed, the rotary control adjusts the channel **Balance** instead. The Balance adjustment is in 0.1dB steps down to -6.0dB on each channel, then mute ($-\infty$) below that. The **Volume** taper on the display changes to show the **Balance** setting.



Balance left



Balance central



Balance right

While the menu is open, the Rotary Control pages forward and backwards through the menu instead of changing the volume.

REAR PANEL

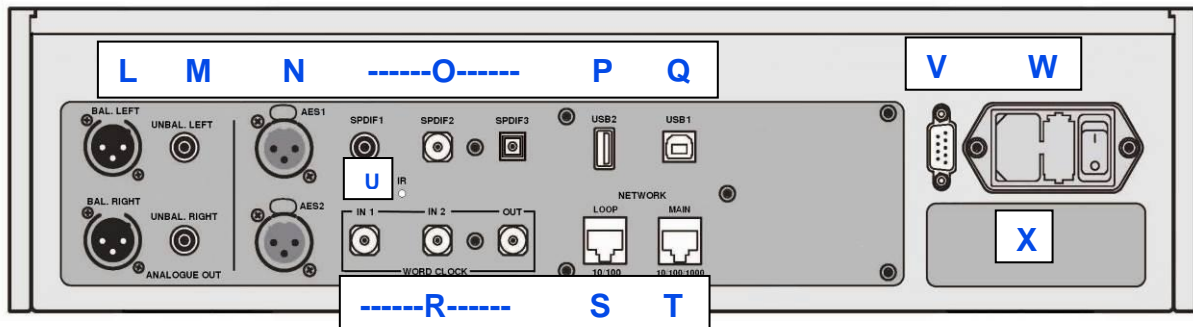

Figure 9 – Rear panel

Analogue Outputs

The unit features independent **Balanced Outputs** (L) on XLR connectors and **Unbalanced Outputs** (M) on RCA connectors. The Left channel outputs are in the top row and the Right channel outputs are on the lower row.

Our **Balanced Outputs** are intended to be connected to true balanced inputs only. They are electronically balanced and floating, so they behave like an audio transformer. This arrangement enhances the rejection of hum and interference picked up by the cable when used with a true balanced input.

Most other DACs use a much simpler circuit that does not offer the same level of performance.

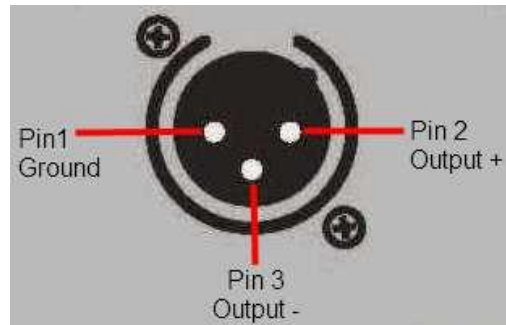

Some amplifier manufacturers provide unbalanced inputs on XLR connectors by leaving pin 3 floating. This arrangement does not work correctly with a floating output stage, resulting in extra noise, unstable signal levels and a “thin” sound. If you want to use the Rossini DAC with this type of input, link pin 3 to pin 1 in the cable at the amplifier end. In such cases, we recommend that you use the **Unbalanced Outputs** instead.

AES Digital Inputs

The **AES1** and **AES2** (N) inputs can be used individually at sample rates up to 192kS/s, including DoP/64.

If the **Dual AES** menu page is set to **On** or **Auto**, **AES1+2** can be used together as a **Dual AES** pair at 88.2, 96, 176.4, 192, 352.8 or 384kS/s. The pair will also accept *dCS*-encrypted SACD data from Vivaldi / Rossini / Scarlatti / Paganini Transports and DoP data (DSD/64 or DSD/128 over PCM).



For Dual AES mode to work correctly, the source must actually generate Dual AES data, not just the same single AES data on 2 connectors!

SPDIF Digital Inputs

The unit features 2 electrical SPDIF inputs, labelled **SPDIF1** and **SPDIF2** (O), which will accept sample rates up to 192kS/s including DoP/64. **TOS** (O) is a Toslink optical receiver that is guaranteed at up to 96kS/s but may be usable at up to 192kS/s. Pull out the dust cover before using the **TOS** input.

USB Interfaces

Both USB interfaces operate in True Asynchronous USB mode, which makes the Rossini DAC immune to clock jitter from the computer / sound server. The DAC uses its own internal clock or locks to the Master Clock connected to one of the **Word Clock** inputs. Feedback through the USB cable to the computer controls the data delivery rate.

The **USB1** client interface on a 'B' type connector (Q) will accept PCM data at up to 24 bits / 384kS/s from a Windows™ PC, Apple Mac™ PC or sound server equipped with a suitable USB2.0 interface. The interface will also accept DSD/64 or DSD/128 data packaged in DoP format.



We have tested this interface with several common formats running on Windows™ 10, Windows™ 8.1, Windows™ 7 (SP1) and Apple Mac™ OSX 10.11 with various PCM streaming programs but we cannot accept responsibility for correct operation with all source devices, operating systems or software.

The **Unit Settings > USB Class** menu page can set the interface to **Class 1** (up to 96kS/s without a special driver) or **Class 2** (up to 384kS/s, no driver is required for OSX 10.6.3 onwards, the current dCS USB Class 2 driver is required for Windows).

The **USB2** host interface (P) on an 'A' type connector can stream PCM music files in most popular formats at up to 24 bits / 384kS/s or DSD/128 from a USB Flash Drive. With a Flash Drive connected, a basic browser (see page 19) navigates to the music files and selects the file to be played. After closing the browser, the name of the file is displayed, with a Play or Pause icon and the elapsed playing time.

Low-power USB hard disk drives in FAT16, FAT32 or un-encrypted NTFS format may be used in the same way. The interface will not read drives in other formats.

Word Clock Inputs and Output

Each of the two **Word Clock In** connectors (R) will accept standard word clock from the source equipment or a master clock at 44.1, 48, 88.2, 96, 176.4 or 192kHz. The clock frequency **MUST** be an exact multiple of the data rate, otherwise the system will not lock. Use the **Unit Settings > Sync mode** menu page to lock the selected input to the selected external word clock. The source **MUST** be locked to the same clock, otherwise the system will not be locked and periodic clicks or other undesirable noises or dropouts will be heard on the outputs.



Each of the **Word Clock In** inputs may be used individually, but to make operation easier, the DAC's **Sync mode** menu page features an automatic mode. In this mode you can (for example) connect a 44.1kHz word clock to **Word Clock In1** and a 48kHz word clock to **Word Clock In2**. With a source connected to another feed from the same Clock, the DAC can select the correct clock frequency.

When the unit is set to Master mode, the DAC uses its internal clock instead of locking to the data or one of the **Word Clock In** inputs. The **Word Clock Out** connector carries a word clock at the same frequency as the single-wire input sample rate, up to a maximum frequency of 192kHz.

If the selected input is **AES** or **SPDIF**, the source equipment **MUST** be locked to the DAC's **Word Clock Out** so that the system can lock.

Word clock is used for synchronisation only, it does not carry digital audio data.

Network Interface

The **Network Main** connection on an RJ45 socket (T) allows the DAC to stream music data from the local network as well as from several internet services. The DAC can stream music files at up to 24 bits / 384kS/s or DSD/64 or DSD/128 under the control of **dCS Mosaic Control** (see page 5) running on a suitable handheld device. The Network interface runs in asynchronous mode and is galvanically isolated.

The **Network Loop** connection on a second RJ45 socket (S) is intended for future expansion and its use is at this time unsupported.



The RJ45 socket's contacts can be damaged by accidentally inserting the wrong connector (e.g. a USB type B or type A). To avoid this, we suggest leaving the dust cover fitted when not in use and connecting the RJ45 cable immediately after removal.

IR Remote Receiver

This secondary IR remote receiver (U) is intended to be used with a household automation system, as an alternative to RS232.

RS232 interface

The **RS232** interface (V) on a 9-way male D-type connector is an RS232 interface with two operating modes, set by the **Unit Settings > RS232** menu page.

- **B**inary mode is used to remotely control the unit during automated production testing at **dCS**. The baud rate is 4800.
- **T**ext mode is for use with a household automation system. The baud rate is 115200. If you would like to use this mode, please send a HELP command to see a list of available commands.

The interface is designed to be used with a “straight through” cable, wired pin 1 to pin 1, etc.

The pin connections are:

- Pin 2 – **dCS** unit transmit
- Pin 3 – **dCS** unit receive
- Pin 5 – ground
- Shell – cable screen & drain wire

An RS232 connection from the DAC to the Rossini Clock's RS232 Loop connector acts as a power link, allowing the two units to be powered on or off together.

Mains inlet

Power is connected via a standard IEC320 connector (W), protected by a fuse and isolated by a 2-pole power switch.

Label

The label (X) states the unit's serial number and the nominal voltage to which the unit is set. It is important to quote the serial number if you need assistance.

THE MENU

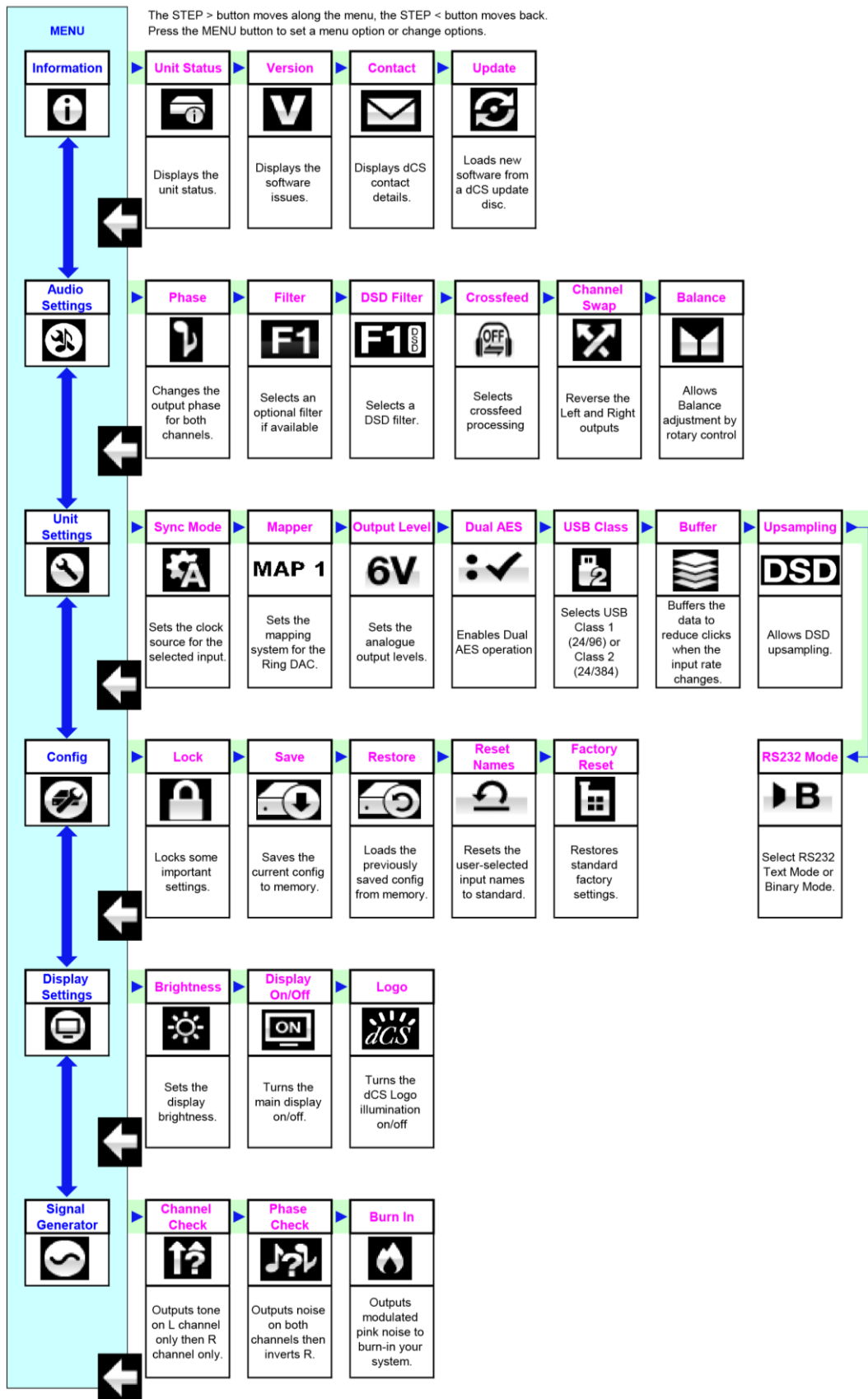

Figure 10 – The menu sequence

Using the Menu

The menu gives the user access to a range of additional features. It also allows new features and performance enhancements to be added later by software updates.

Note that **dCS Mosaic Control** can also be used to control audio and unit setting, access product information and check for firmware updates.

The menu is controlled by four buttons.

- Press the **Menu** button to open the menu or select a setting.
- Press the **▶** button to page forward through the menu.
- Press the **◀** button to page backward through the menu.
- Press the **Power** button to close the menu. Most menu pages close after about 7 seconds.
- While the DAC's menu is open, the Rotary Control pages forwards or backwards.



Use the Menu Guide sheet to help you find the right menu page.

There are six top-level menu pages:



The **INFORMATION** menu gives unit set-up details, software issues, serial number and contact details.



The **AUDIO SETTINGS** menu allows you to set some features that are not directly accessible from the front panel.



The **UNIT SETTINGS** menu sets up the unit to suit your system.



The **CONFIGURATION** menu allows you to lock important settings, save a standard setup and reset the unit.



The **DISPLAY SETTINGS** menu is used to adjust the display.



The **SIGNAL GENERATOR** menu contains test and set-up routines.

Use the **▶** button to move the blue highlight to the menu you want, then press the **Menu** button to select it. The next menu level down is displayed. Use the **▶** button to move the highlight to the menu page you want, then press the **Menu** button to display the information or change the setting.



Select the return icon to go back to the previous menu level.

INFORMATION Menu

Unit Status



The **Unit Status** page displays:

- The long version of the serial number, including the hardware configuration code.
- The unit name.
- The internal temperature°C.
- The IP address of the unit (if it is connected to a network).
- Each Word Clock input and the clock frequency detected on that input.
- Each input and the sample rate detected on that input.
- For MQA data, the final rendered sample rate.

Use the ◀ ▶ buttons to scroll up or down the list. This page does not time out, press the **Menu** button to exit.

Mosaic Control location: **SETTINGS > SUPPORT > Status**



If your system is not behaving as you expect, the **Unit Status** page can help you find set-up or connection errors.

Version



The **Version** page displays the software versions loaded in the unit. Please have this information ready if you contact your dealer for any reason:

- Main: 2.0x (this is the main software version)
- Network: the network firmware build code

This page does not time out, press the **Menu** button to exit.

Mosaic Control location: **SETTINGS > SUPPORT > Versions**

Contact



The **Contact** page displays the *dCS* web-site URL and support email address. This page does not time out, press the **Menu** button to exit.

If you have any difficulty, please contact your dealer for help first.

Update



The **Rossini DAC** is intended to be updated over the internet using *dCS Mosaic Control* (see page **50**) – this is the easiest and safest way to do it. This feature is provided for emergency use only. We do not promise to make CD Update files available for all versions.

Mosaic Control location: **SETTINGS > SUPPORT > Versions > Check for updates**

AUDIO SETTINGS Menu

Phase



Use this page to change the phase of all the analogue outputs from normal phase...



...to inverted phase, to correct for absolute phase errors on recorded music. This icon is displayed when the outputs are inverted. Phase is reset to normal to power up.

Mosaic Control location: **SETTINGS > SYSTEM TEST**

Filter



The Rossini DAC features two sets of digital filters: one set for PCM and one set for DSD. The PCM Filter is applied when the unit is receiving PCM data. Filters are a personal choice.



The DAC remembers the last filter set for every sample rate.



The first 4 PCM filters give different trade-offs between the Nyquist image rejection and the phase response. **Filter 1** has the best rejection of (unwanted) Nyquist images and the sharpest roll-off, resulting in the poorest transient response of the four. Filters 2, 3 and 4 have progressively more relaxed image rejection and progressively better transient response. **Filter 2** is often preferred for orchestral music, while **Filter 3** and **Filter 4** are often used for rock music.



If the source data rate is 176.4, 192, 352.8 or 384kS/s, two extra filters are available. **Filter 5** has a Gaussian response (which has no overshoot on transients, with a relaxed roll-off) and **Filter 6** is an asymmetrical type (which features almost no pre-ringing).



There are 2 extra filters for 44.1kS/s operation also. **Filter 5** is an asymmetrical design with non-linear phase and no pre-ringing. **Filter 6** is a new sharp filter which has linear phase and pre-ringing. Try them and decide for yourself which you prefer.



While receiving and decoding MQA format data, **Filter M1** may be selected in addition to 6 other filters. This is the recommended filter for MQA. The MQA filter setting is stored separately as if it were an extra sample rate.

Mosaic Control location: **SETTINGS > AUDIO > dCS Processing Platform**

DSD Filter



The DSD Filter is applied when the unit is receiving DSD data or when the DSD Upsampling feature is active. While upsampling PCM data to DSD or DSDx2, both filters are active, but only the PCM Filter setting appears on the display.



DSD mode has 5 filters, the first 4 progressively reduce the out-of-band noise level (which is inherent in the 1-bit nature of DSD). **Filter 1** is the usual setting – it gives the widest bandwidth (90kHz for DSD/64) and the highest level of out-of-band noise. If your system sounds harsh, try **Filter 2** or **Filter 3**. These progressively reduce the out-of-band noise level at the cost of some bandwidth. **Filter 4** is primarily intended for troubleshooting, not listening, as it cuts off sharply (above 25kHz for DSD/64) to minimise the out-of-band noise. **Filter 5** has a relaxed roll-off with a smoother phase response – this also removes much of the out-of-band noise.

Mosaic Control location: **SETTINGS > AUDIO > dCS Processing Platform**

Crossfeed (*dCS Expanse*)

Crossfeed is the process of blending left and right channels of a stereo audio recording, to help make audio sound more natural when played through headphones. The crossfeed setting that is most suitable for you and the music you are listening to may vary, so we recommend testing the different settings.

dCS Expanse is our patented processing algorithm. It applies different processing filters to give two different responses: E1 and E2. With Expanse, there is a unique headphone listening experience for all listeners that stays true to the original recording.



Crossfeed off. The two audio channels are presented to the headphones in the usual way



Crossfeed on. Some of the signal from one channel is filtered and mixed with the other channel to better imitate listening to loudspeakers in a room.



Expanse E1. A crossfeed processing algorithm that uses different processing filters.



Expanse E2. A crossfeed processing algorithm that uses different processing filters.

Channel Swap



This feature swaps the channels from normal...



...to swapped to correct a connection error. Correct the error and change back to normal. **Ch Swap** does not affect the **Channel Check** feature, it is reset to normal at power up.

Mosaic Control location: **SETTINGS > SYSTEM TEST**

Balance



The operation of the rotary control changes to adjust the balance. Each channel can be varied from 0dB to -6dB in 0.1dB steps, then mute ($-\infty$) below that. Press the **Menu** button to end **Balance** adjustment. Most owners use the Rossini app to adjust the balance.

Mosaic Control location: **SETTINGS > DEVICE**

UNIT SETTINGS Menu

These settings are usually “set and forget”.

Sync Mode

This page sets the clocking for the digital input that is currently selected. The DAC remembers the **Sync Mode** setting separately for each digital input. The options are:



Audio – The DAC extracts the clock from the data stream connected to the selected digital input and locks to it. Use this setting for sources that do not have a suitable Word Clock input. This arrangement does NOT give the best jitter performance or the best sound quality. The **USB** and **Network** inputs or cannot be set to **Audio Sync**.



Master – This is the normal mode for the asynchronous **USB** and **Network** inputs where a Master clock is not available. The DAC uses its own internal clock to control the internal DAC and regulate delivery of data packets. In this situation, the DAC is acting as the source device.

When using the AES or SPDIF inputs in Master Mode, the DAC again uses its internal clock to control the DAC and outputs a clock signal at the **Word Clock Output**. For correct Master Mode operation, the source’s word clock input MUST be locked to the DAC’s **Word Clock Output** – this ensures that the source is delivering data at the correct rate.



Word Clock 1-2 Auto – This mode is designed for easy operation with a Rossini Clock in a computer audio system, where the data rate may keep changing. Connect the **Word Clock In1** input to a Clock output set to 44.1 or 88.2 or 176.4kHz and connect the **Word Clock In2** input to a Clock output set to 48, 96 or 192kHz. When the sample rate changes, the DAC will automatically select a Word Clock frequency that is synchronous with the data. The selected word clock input appears on the main display.



Word Clock 1 – The DAC locks to an external clock connected to **Word Clock In1**.



Word Clock 2 – The DAC locks to an external clock connected to **Word Clock In2**.

Mosaic Control location: **SETTINGS > DEVICE**



If the DAC cannot find a word clock that is synchronous with the data on the selected AES or SPDIF input, it will default to **Audio** sync and display the “Bad Clock” icon.

Mapper

The **Mapper** controls the way in which data is presented to the Ring DAC™ core. There are now 3 Mapper options:

MAP 1

Map 1 is the new default mapper. It drives the Ring DAC™ core at either 5.644 or 6.14MHz.

MAP 2

Map 2 is the classic mapper design, used on all 1.xx versions of the Vivaldi DAC and Rossini, based on the design used by *dCS* for the last 20+ years. It drives the Ring DAC™ at 2.822 or 3.07MHz.

MAP 3

Map 3 is an alternative design, which also runs at 5.644 or 6.14MHz.

Our listening tests concluded that **Map 1** gives the most musical results, but you have a choice.

Mosaic Control location: **SETTINGS > AUDIO > dCS Processing Platform**

Output Level

6V

This page sets the full scale output level to **6V**, **2V**, **0.6V** or **0.2V** rms to allow you to match the DAC's output level to your amplifiers, speakers and room.

2V

When you set up your system, choose the **Output Level** setting that gives a comfortable listening level with the **Volume** set between **-10dB** and **-30dB**. The difference between two adjacent settings is about 10dB.

.6V

The lower settings are intended to prevent accidents when driving the amplifiers directly and AirPlay is in use, as the volume set by the sending device can be very high.

.2V

Mosaic Control location: **SETTINGS > AUDIO > Output**

Dual AES

This setting allows the **AES1** and **AES2** inputs to be used together to accept PCM data at high sample rates (88.2, 96, 176.4, 192, 352.8 or 384kS/s) or DSD/64 or DSD/128 from a Dual AES source. Note that a source with two AES outputs might not actually produce Dual AES data! The settings are:

:X

- **Off** – Dual AES mode is disabled. Both inputs accept single AES data.

:✓

- **On** – Dual AES mode can be manually selected using the **Input** button or by remote control.

:A

- **Auto** – The unit detects the format flags in the digital data and automatically sets the **AES1** & **2** inputs to Single AES or Dual AES mode as required. This is the usual setting. Note that if the format flag in the data is wrong, you will need to manually select the correct setting.

Mosaic Control location: **SETTINGS > DEVICE**

USB Class



Set to **Class 1**, the **USB1** interface will operate with Mac PCs running OSX 10.5 onwards or Windows PCs at sample rates up to 96kS/s.



Set to **Class 2**, the **USB1** interface will operate with Mac PCs running OSX 10.11 onwards at sample rates up to 384kS/s or DSD/128. **Class 2** operation with Windows PCs requires that the dCS USB Class 2 Driver is loaded.

Mosaic Control location: **SETTINGS > DEVICE**

After selecting a different USB Class, wait for 10 seconds while the USB software is re-loaded.



Note that the **USB1** interface will not be detected by a Windows computer if the unit is set to **Class 2** and a suitable driver is not available.

We recommend that you stop playback and close the streaming program before changing the **USB Class** setting.

Buffer



Set to **On**, the digital data is delayed before being presented to the Ring DAC – this is the usual setting. The delay is 0.72 seconds with 44.1kS/s data and 0.16 seconds with 192kS/s data. The delay gives the DAC time to detect changes in sample rate or clock frequency and mute before the change causes audible clicks or other noises.



The extra delay is not a problem with music, but if the DAC is used with television or video, it may cause the sound to be out of sync with the picture. To prevent this, set the **Buffer** to **Off**.

Mosaic Control location: **SETTINGS > DEVICE**

Upsampling



Set to **DSD**, the DAC inserts a DSD upsampling stage towards the end of the PCM oversampling sequence, before conversion to analogue.



Set to **DSDx2**, the DAC inserts a DSDx2 upsampling stage towards the end of the PCM oversampling sequence, before conversion to analogue.



Set to **DXD** the DAC uses its standard PCM oversampling sequence for PCM data.

This feature does not apply to DSD data, which is processed differently.

Mosaic Control location: **SETTINGS > AUDIO > dCS Processing Platform**

RS232 Mode



This page sets the RS232 interface to either **T**ext mode for use with 3rd-party control systems or...



...*dCS* production **B**inary mode, which is intended for factory use only.

CONFIGURATION Menu

Settings Lock



When set to **Locked**, this icon appears on the main display and the following settings cannot be changed:

- **Mapper**
- **Sync Mode** setting for all inputs
- **Output Level**
- **Dual AES**
- **Ch Swap**
- **Balance**
- **DSD Filter**
- **USB Class**
- **Save Configuration** is disabled
- **Restore Configuration** is disabled
- **Factory Reset** is disabled



Set to **Unlocked** if you need to change these settings.

Save Configuration



Once the unit is set up the way you want it, select **Save** to store the settings in memory. If you deliberately change the setup later and want to keep it, select **Save** again to store the changes.

Restore Configuration



If the unit settings are accidentally changed, select **Restore** to reload the settings you saved earlier.

Reset Input Names



If the inputs have been renamed, selecting this page resets them to the original names: AES1, AES2, etc.

Factory Reset



This page resets the unit to the following standard setting:

- **Volume** to **-30dB**.
- **Balance** to **centre**.
- **Input** to **Network**.
- **Mapper** to **Map 1**.
- **Sync** to **Audio** for all inputs, except
- **USB & Network** sync to **Word Clock Auto (W)**
- **PCM Filter** to **1** for all sample rates.
- **DSD Filter** to **1**
- **Dual AES1+2** to **Auto**.
- **Phase** to **Normal**.
- **Output Level** to **2V**.
- **Display** to **On**.
- **Brightness** to **maximum**.
- **RS232 Mode** to **Binary**.
- **Ch Swap** to **Normal**.
- **Buffer** to **On**.
- **Upsampling** to **DSD**
- **Logo** to **On**

DISPLAY SETTINGS Menu

Brightness



Set the display **Brightness** to a comfortable level using the ◀ or ▶ buttons. Press the **Menu** button to exit.

Mosaic Control location: **SETTINGS > DISPLAY**

Display On/Off



This page is usually set to **On**.



When set to **Off** and the menu closes, the display will turn off after a few seconds. The display will turn on briefly when a control setting is changed. The display will stay on if the menu is open.

Mosaic Control location: **SETTINGS > DISPLAY**

Logo On/Off



When set to **On**, the *dCS* logo at the left side of the display is illuminated.



When set to **Off**, the logo is not illuminated.

Mosaic Control location: **SETTINGS > DISPLAY**

GENERATOR Menu

Channel Check



This routine tests the system for swapped channels. A tone is output on the left channel only while the display shows **Left Channel**, then the right channel only while the display shows **Right Channel**. If these are the wrong way around, the left and right channels are swapped somewhere in your system.

Mosaic Control location: **SETTINGS > SYSTEM TEST**

Phase Check



This routine tests the system for phase reversals. Noise is output in phase on both channels while the display shows **In Phase**. After a few seconds, the noise on the right channel is inverted while the display shows **Out Phase**. The first burst should produce a central image, the second burst should not. If these are the wrong way around, one channel in your system is phase inverted.

Mosaic Control location: **SETTINGS > SYSTEM TEST**

Burn In



This page runs a procedure to condition your system. The unit displays **Burn In Warning – Loud!**, **Press any button to quit**, then outputs modulated pink noise that ramps up and down slowly in level. Press any button to stop the procedure.



Please ensure that the volume level is reasonable, as careless use of the **Burn In** feature can damage your amplifiers and loudspeakers. dCS will not be liable for such damage.

CONFIGURATION WITH MOSAIC CONTROL

Many of the settings that are contained in the device's **Menu** (detailed above) are also accessible from within the *dCS Mosaic Control* application.



Tapping the **SETTINGS** button will open the settings drawer from the left side of the screen.

The following functions are available through the settings interface.

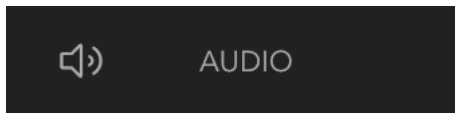

The **AUDIO** button will display the signal path of your unit and allow you to change settings related to input, output, and signal processing.

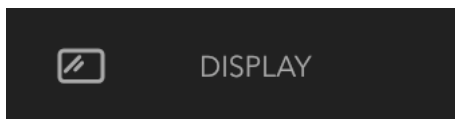

The **DISPLAY** button will allow you to modify settings related to the device's front panel display.

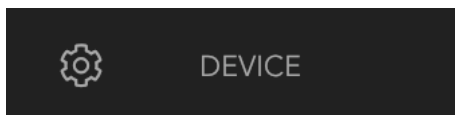

The **DEVICE** button will allow you to change device-related settings and less-frequently-used audio-related settings.

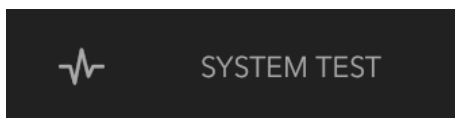

The **SYSTEM TEST** button will allow you to run a number of tests to ensure your device is connected properly.

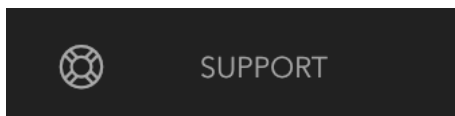

The **SUPPORT** button will display information about the current status of the device, its installed software, as well as allow you to check for software updates.

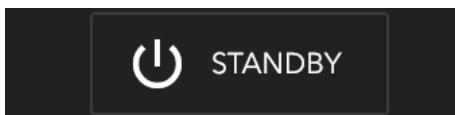

Holding the **STANDBY** button for two seconds will place your unit into sleep mode. This is the equivalent of a press of the front panel **Power** button.

Directions to the location of a specific setting within Mosaic Control are provided along with its description in the MENU section of this manual. For instance, the **Filter** setting is at the following location:

SETTINGS > AUDIO > dCS Processing Platform

That means that to access the Filter setting you would execute the following steps in *dCS Mosaic Control*:

- Tap the **SETTINGS** button to open the Settings Drawer
- Tap **AUDIO** to open the Signal Path
- Tap the **dCS Processing Platform** area to open the filter selector

SPECIFICATION

Converter type	dCS proprietary Ring DAC™ topology.
Digital inputs	<p>UPnP Network interface on an RJ45 connector streams music files from a NAS or local computer using MinimServer over an Ethernet network. Supported file formats are:</p> <ul style="list-style-type: none"> • FLAC, AIFF & WAV – up to 24-bit PCM at 44.1, 48, 88.2, 96, 176.4, 192, 352.8 or 384kS/s. • ALAC – up to 24-bit PCM at 44.1, 48, 88.2, 96, 176.4 & 192kS/s. • AAC, MP3 - up to 24-bit PCM at 44.1 or 48kS/s. • DFF, DSF & DoP – DSD/64 & DSD/128 <p>Supports TIDAL, Qobuz, Deezer, Internet Radio and Podcasts via AirAble.</p> <p>The interface will accept audio data streamed from a suitable mobile device via Apple AirPlay at 44.1 or 48kS/s.</p> <p>The Network interface operates in Asynchronous mode.</p>
	<p>USB1 interface on a B-type connector, will accept up to 24 bit PCM at:</p> <ul style="list-style-type: none"> • 44.1, 48, 88.2 or 96kS/s when set to USB Class 1 (no driver required). • 44.1, 48, 88.2, 96, 176.4, 192, 352.8 or 384kS/s when set to USB Class 2 (no special driver is required for OSX 10.6.3 onwards, load the latest <i>dCS</i> USB Class 2 driver for Windows). • In USB Class 2, accepts DSD/64 & DSD/128 in DoP format. <p>The USB1 interface operates in asynchronous USB mode.</p>
	<p>USB2 interface on A-type connector, streams audio files from a USB Flash Drive up to 24 bit PCM at 44.1, 48, 88.2, 96, 176.4, 192, 352.8 or 384kS/s or DSD/64 or DSD/128. Compatible formats are listed in the UPnP Network interface section above.</p> <p>The USB2 interface operates in asynchronous USB mode.</p>
	<p>2x AES/EBU on 3-pin female XLR connectors.</p> <p>Each input will accept up to 24 bit PCM at 44.1, 48, 88.2, 96, 176.4 or 192kS/s or DSD/64 in DoP format,</p> <p style="text-align: center;">OR</p> <p>used as a Dual AES pair at 88.2, 96, 176.4, 192, 352.8 or 384kS/s or <i>dCS</i>-encrypted DSD or DSD/64 & DSD/128 in DoP format.</p>
	<p>2x SPDIF on 1x RCA Phono and 1x BNC connectors. Each will accept up to 24 bit PCM at 44.1, 48, 88.2, 96, 176.4 or 192kS/s or DSD/64 in DoP format.</p>
	<p>1x SPDIF optical on a Toslink connector, will accept up to 24 bit PCM at 44.1, 48, 88.2 or 96kS/s.</p>
Clocking	<p>2x Word Clock Inputs on 2x BNC connectors, accept standard word clock at 44.1, 48, 88.2, 96, 176.4 or 192kHz. The data rate can be the same as the clock rate or an exact multiple (0.25x, 0.5x, 1x, 2x, 4x, 8x) of the clock rate. Sensitive to TTL levels.</p>
	<p>Word Clock Output on 1x BNC connector. In Master mode, a TTL-compatible word clock appears on this output, not temperature compensated. The word clock frequency is either 44.1 or 48kHz, depending in the incoming data rate.</p>
MQA	<p>Full decoding and rendering of MQA data from the Network and USB2 inputs. Final rendering of unfolded MQA data only from the other inputs.</p>

Frequency response (set to Filter 1)	<p>Fs = 44.1kS/s +/-0.1dB, 10Hz to 20kHz</p> <p>Fs = 48kS/s +/-0.1dB, 10Hz to 20kHz</p> <p>Fs = 88.2 or 96kS/s +/-0.1dB, 10Hz to 20kHz -3dB @ >38kHz</p> <p>Fs = 176.4 or 192kS/s +/-0.1dB, 10Hz to 20kHz -3dB @ >67kHz</p> <p>Fs = 352.8 or 384kS/s +/-0.1dB, 10Hz to 20kHz -3dB @ >100kHz</p> <p>DSD/64 +/-0.1dB, 10Hz to 20kHz -3dB @ >90kHz</p> <p>DSD/128 +/-0.1dB, 10Hz to 20kHz -3dB @ >100kHz</p>
Residual noise (6V output setting)	<p>16-bit data: Better than -96dB0, 20Hz - 20kHz unweighted.</p> <p>24-bit data: Better than -113dB0, 20Hz - 20kHz unweighted.</p>
DSD upsampling	Optional 1-bit 2.822 / 3.07MS/s or 5.644 / 6.14MS/s upsampling (set in the menu) to supplement the multi-stage PCM oversampling.
Spurious responses	Better than -105dB0, 20Hz - 20kHz.
L-R crosstalk	Better than -115dB0, 20Hz - 20kHz.
Output levels	6V, 2V, 0.6V or 0.2V rms on all outputs for a full-scale input, set in the menu.
Balanced outputs	1 stereo pair on 2x 3-pin male XLR connectors (pin 2 = hot, pin 3 = cold). These outputs are electronically balanced and floating, the signal balance ratio at 1kHz is better than 40dB. Output impedance is 3Ω, maximum load is 600Ω (a 10kΩ - 100kΩ load is recommended).
Unbalanced outputs	1 stereo pair on 2x RCA Phono connectors. Output impedance is 52Ω, maximum load is 600Ω (a 10kΩ - 100kΩ load is recommended).
Size and weight	<p>444mm (17.5") wide x 435mm (17.2") deep x 125mm (5.0") high. Allow extra depth for cable connectors. Allow space for air flow around the unit.</p> <p>15.6kg (34.3lbs).</p>
Power requirements	<p>Internally set to either 100, 115/120, 220 or 230/240V AC, 49 – 62Hz.</p> <p>Power consumption: 23W typical, 50W maximum.</p> <p>Consumes less than 0.5W when powered down from the front panel.</p>

These specifications are subject to change without notice.

MAINTENANCE AND SUPPORT

Service and Maintenance

dCS audio products are designed not to need regular maintenance, and contain no user serviceable parts apart from the mains fuse. If your unit is damaged in any way, please contact your dealer.

Replacing a Blown Mains Fuse

There is a mains fuse below the power inlet, accessible from the outside of the unit. If the fuse blows, it may be changed by the user. The current consumption of the unit is very low, so it only blows if power surges occur, or there is a fault in the unit. Usually power surges cause no other damage, but if the fuse blows repeatedly on replacement, some other damage will have been done - contact your dealer to arrange repair.

Fuse type: 20 x 5mm T 1A L fuse



If the fuse should fail, it is essential that it is replaced with one of the same type and rating. Failure to do so could result in damage to the unit, risk of fire or electric shock and will invalidate the warranty. Fuse failure is rare!

Referring to the diagram below, remove the power cable, use your fingernails to catch the two tabs of the fuse holder (A), push them together to release the clips and pull the fuse holder out. Pull out the blown fuse from the lower position (B) and discard it. Either move the Spare Fuse (C) to the lower position or fit one of the fuses from the manual pack. Orient the fuse holder as shown (D) and push the holder back into the power inlet so that it clicks home.

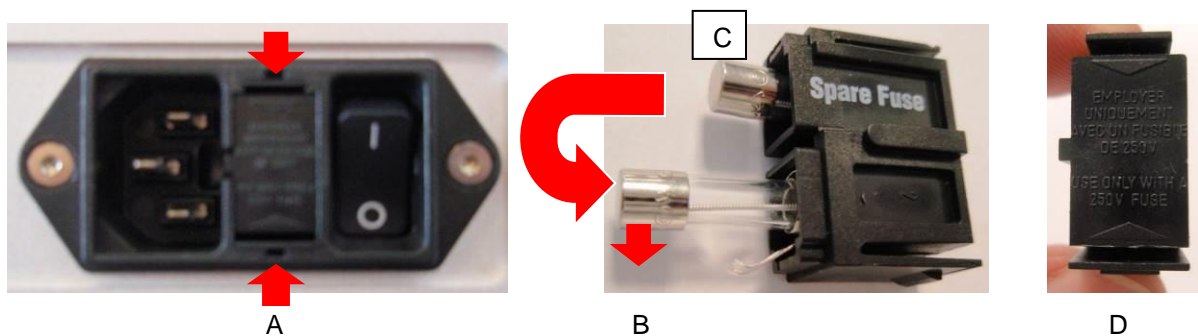

Cleaning the case

The front and back panels of your dCS equipment are machined from very high grade aluminium. Great care has been taken to create the finish of the aluminium throughout the engineering process from the raw solid material to the finished piece.

To remove loose dust or finger marks from the case, we recommend that you use a clean, dry, lint-free cloth.

To restore the finish, we recommend applying small quantities of a lanolin based cleaner, using a clean, dry, lint-free cloth and then wiping off. Do not allow lanolin to collect around the buttons.

Small amounts of glass cleaner containing ammonia may be used to clean other surfaces, but avoid spraying onto the connector contacts.

Limited Warranty

General

dCS warrants this product against defects in materials and workmanship for a period of 3 years from the date the unit was originally shipped from dCS. If the product is purchased and registered with dCS within 6 months of the date the unit was originally shipped from dCS, we will start the warranty on the purchase date. For units registered later than 6 months from the ship date, we will start the warranty from the ship date unless the registration is supported by the original sales invoice. During the warranty period, dCS will repair or, at our absolute discretion, replace a faulty product. Warranty repairs must only be carried out by dCS or our authorised service agents. Please contact your dealer if your unit requires service.

To register this product, either register online at www.dcsaudio.com or complete the **Product Registration** form within 30 days of the sale and return it to dCS. On receipt of the registration, dCS will add your contact details to our customer database. dCS will use this information for warranty purposes only, we will not contact you directly for reasons relating to sales and marketing.

This warranty applies to the original owner, it is not transferable.

Warranty Exclusions

The Warranty does not cover wear and tear.

The Warranty on this product will be void if:

- the product is misused in any way.
- any unauthorised modifications or repairs are carried out.
- the product is not used in accordance with the Operating Conditions stated in this manual.
- the product is serviced or repaired other than by dCS or our authorised service agents.
- the product is operated without a mains earth (or ground) connection.
- the unit is returned inadequately packed.

dCS reserve the right to apply a service charge if a product returned for warranty repair is found to be operating correctly, or if a product is returned without a returns number being issued.

This warranty covers parts and labour only, it does not cover shipping charges or tax/duty.

Our dealers or distributors are NOT authorised to extend the terms of this warranty, dCS cannot accept responsibility for any attempt to do so.

Products re-sold by dCS on a “used” basis may be subject to reduced warranty terms.

Obtaining Service

Should you encounter a problem, contact your authorised dCS dealer for advice, quoting the model, the full serial number, software version number, and giving a detailed description of the fault. Your dealer will advise you fully on actions that need to be taken. When returning a unit, the original packaging should be used to avoid transit damage. Replacement packaging sets may be purchased from dCS.

During the Warranty period, there will normally be no charge for parts or labour.

Operating Conditions

- The supply voltage must remain within +/-10% of the A.C. voltage specified on the back panel.
- The supply frequency must be in the range 49Hz to 62Hz.
- Ambient temperature range: 0°C (32°F) to 45°C (113°F), non-condensing.
- Do not install the unit near heat sources such as radiators, air ducts, power amplifiers or direct strong sunlight.
- If in doubt, the easy test is – the unit is happy to work anywhere a human is.

If you need more help

In the first instance, you should contact your dealer. If they cannot resolve the issue, contact your national distributor.

Manufactured by:

Data Conversion Systems Ltd.
Unit 1, Buckingway Business Park,
Anderson Road,
Swavesey,
Cambridgeshire. CB24 4AE
UK

www.dcsaudio.com

This user manual may be downloaded free of charge from our web-site.

A bound copy of this manual may be ordered from *dCS*.

Software History

dCS products make extensive use of software configurable chips – FPGAs and DSPs. This gives us the ability to update our products to add extra features, update digital interface standards or make performance improvements by loading new software. Occasionally, a hardware upgrade may be necessary also to increase the “capacity” of the electronics, add extra connectors or extra front panel controls.

Please note that not all software updates produce an audible improvement. We recommend that you keep your software up to date. Check the dCS web-site occasionally for news of the latest software updates.

This manual is for **Rossini DAC** software version 2.0x.

Issue 1.00	The first issue.
Issue 1.01	Updated to improve integration with the Rossini app. Network firmware v81. Various bug fixes / minor improvements.
Issue 1.02	Updated to improve integration with the Rossini app v1.0.3. Network firmware v127. Improved Apple AirPlay performance. Various bug fixes / minor improvements.
Issue 1.02	Network firmware v183 with the Rossini app v1.0.8 adds Tidal support. The main software is unchanged.
Issue 1.03	Network firmware v198 with the Rossini app v1.1.8. Improved behaviour when playing WAV or DSF files with cover art appended over the Network. Index Threshold and Logo on/off added to the app. Various minor improvements and bug fixes.
Issue 1.04	Roon and RS232 remote control support added. Network firmware v307.
Issue 1.05	Corrects an updating bug, various minor corrections. Network firmware v327.
Issue 1.11	MQA support added. Network firmware v368. App v1.4.8.
Issue 2.00	Two new 6MHz Mappers added. DSD Filter 5 added. DSD/128 upsampling option added. App support for Rossini Transport added. Non-Audio muting added for when driven by a Rossini Transport. MQA playback behaviour improved. Network firmware v405. Rossini app version 1.4.9.
Issue 2.00	Control Board v2.00 with network firmware v501 and dCS Mosaic Control v1.0.x.
Issue 2.02	Control Board v2.02 with network firmware v506. Fixed an issue where DSD files were being truncated upon starting playback. TOSLINK input no longer causes "NON-AUDIO" to be shown on the unit display.
Issue 2.03	Control Board v2.03 with network firmware v507. Minor bug fixes.
Issue 2.04	Control Board v2.04 with network firmware v507. Fixed an issue where certain content would not play correctly.
Issue 2.1	Control Board v2.1 with network firmware v509. Crossfeed & dCS Expanse feature support. Fixed an issue where a connected Rossini Transport occasionally entered repeat.

Software update

The Rossini DAC v1.01 onwards can be updated from the internet over the network using **dCS Mosaic Control** app. Tap **SETTINGS > SUPPORT > Versions > Check for Updates**. If an update is available, please follow the prompts and then wait until the process is complete.

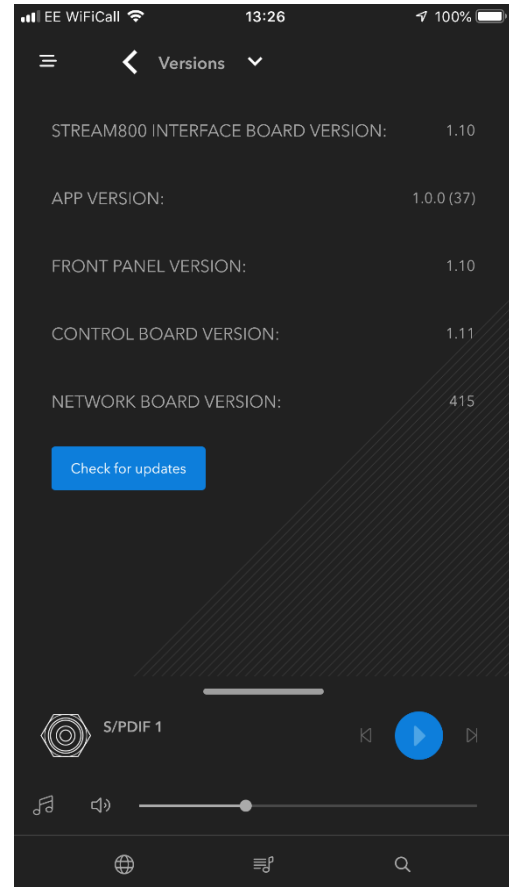
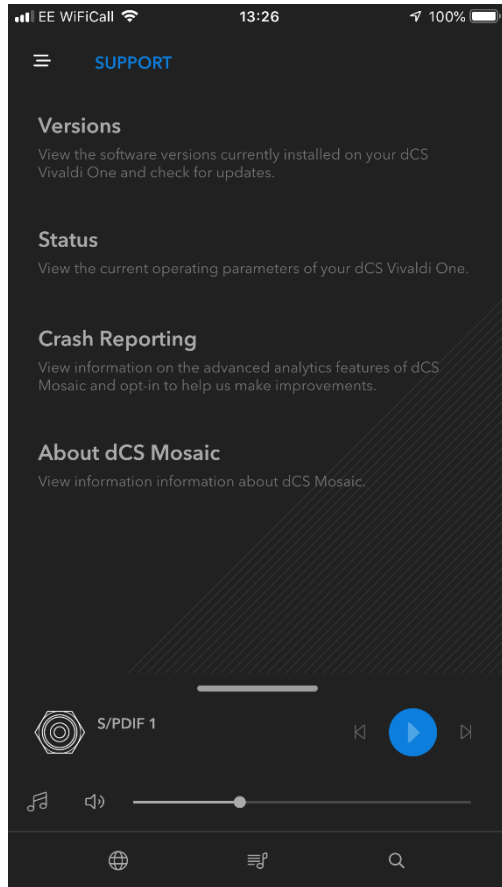

An update can take 45 minutes, please be patient.
Please do not switch the unit off until "Please switch off" is displayed.

INDEX**O**

0/44.1 display 15

A

AES input..... 15, 29

AirPlay 12

audio settings menu 35

B

balance 28, 36

browser..... 19, 27

navigate up 28

buffer..... 39

burn in..... 42

C

cables 9

ch swap..... 36

channel check..... 42

cleaning 46

compatibility

operating systems.. 16, 30

UPnP control point 8

condensation 6

configuration

reset 40

restore 40

save..... 40

configuration menu 40

contact 34

control modes 27

D

display

brightness 41

DAC..... 26

Mosaic..... 25

off 41

display menu 41

Dual AES input 14, 29, 38

F

file formats 44

filter

button 27

DSD..... 35

PCM 35

flash drive 19

front panel..... 25

fuse, replacing 46

G

generator menu 42

I

information menu..... 34

input

AES 15, 29

button 28

Dual AES 14, 29

network 11, 31

rename 23

SPDIF 15, 29

Toslink..... 29

USB1..... 16, 30

USB2..... 19, 30

word clock 30

input selection..... 14

Mosaic Control 28

L

lock 40

logo off..... 41

M

mains inlet 31

mapper 37

master mode..... 21, 37

menu..... 32

audio settings..... 35

button 27

configuration 40

display 41

generator..... 42

information 34

unit settings..... 37

using 27, 33

menu back button 27

menu forward button..... 28

Mosaic 5, 11, 31, 43, 50

Deezer 12

device configuration 43

display 25

input selection 28

internet radio 12

mosaic control..... 11

podcasts..... 12

Qobuz 12

TIDAL..... 12

updates 50

UPnP..... 11

user guide 11

using with Roon 12

MQA 13, 25

file tags..... 13

mute button..... 28

N

NAS drive 11

network

input 11, 31

setup 11

O

operating conditions 47

output

analogue 10, 29

word clock 30

output level 10, 38

P

PC setup..... 17

phase..... 35

phase check 42

positioning 6

power

button 27

link..... 24

off 27

up 9

preamplifier..... 10

R

rear panel 29

remote control 26

rename input 23

rename unit 24

reset..... 23, 40

restore configuration..... 40

Roon Ready 12

RS232..... 31, 39

S

safety 6, 7

save configuration 40

serial number..... 31, 34

service 46

settings lock..... 40

setup guide 9

sleep 27

software 34, 49

SPDIF input 15, 29

specification..... 44

Spotify..... 12

status 34

sync mode 20, 37

sync to Master Clock . 20, 22

T

Toslink input 29

U

unit settings menu 37

update..... 34, 50

upsampling 23, 39

USB

class..... 16, 30, 38

Windows driver 16

USB1 input 16, 30

USB2 input 19, 30

V

version 34

voltage 31

volume control 28

W	
wake	27
warranty	47
word clock.....	30, 37